

The background features several decorative wrought iron elements. At the top, there is a circular scrollwork design. To its right, a pair of black leather work gloves is visible. The bottom half of the image is dominated by a large, vibrant burst of orange and yellow sparks, suggesting a welding or forging process. In the foreground, there are more decorative iron scrolls and a pair of black leather work gloves, mirroring the elements at the top.

декоративные кованые элементы
для сборки художественных и кузнечных металлоконструкций

kovkarb

2017



 **kovkarb**



kovkarb.by

12 x 6



NR ART	01.031	01.032	01.033	01.033.01	01.034	01.035	01.036	01.037
H x L (mm)	80 x 45	95 x 60	100 x 60	110 x 65	115 x 70	120 x 60	130 x 70	150 x 80
∅ (mm)	∅ 12 x 6	∅ 12 x 6	∅ 12 x 6	∅ 12 x 6	∅ 12 x 6	∅ 12 x 6	∅ 12 x 6	∅ 12 x 6
W (kg)	0,107	0,132	0,132	0,142	0,156	0,156	0,156	0,185

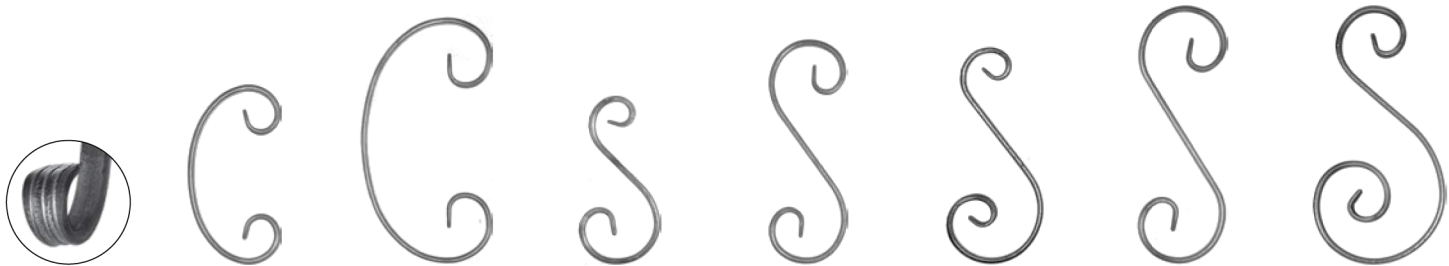

NR ART	01.038	01.039	01.040	01.040.05	01.041	01.041.05	01.042
H x L (mm)	160 x 80	220 x 115	150 x 70	200 x 70	195 x 80	230 x 80	230 x 115
∅ (mm)	∅ 12 x 6	∅ 12 x 6	∅ 12 x 6	∅ 12 x 6	∅ 12 x 6	∅ 12 x 6	∅ 12 x 6
W (kg)	0,185	0,265	0,185	0,220	0,220	0,283	0,317



NR ART	01.042.05	01.043	01.045	01.046	01.047	01.048	01.049
H x L (mm)	290 x 115	260 x 110	250 x 60	450 x 80	150 x 80	100 x 60	120 x 70
∅ (mm)	∅ 12 x 6	∅ 12 x 6	∅ 12 x 6	∅ 12 x 6	∅ 12 x 6	∅ 12 x 6	∅ 12 x 6
W (kg)	0,420	0,278	0,220	0,371	0,156	0,107	0,132

11 x 5



NR ART	01.061	01.062	01.063	01.063.01	01.064	01.065	01.066	01.067	01.068	01.069
H x L (mm)	80 x 45	95 x 60	100 x 60	110 x 65	115 x 65	120 x 60	130 x 70	150 x 80	160 x 80	220 x 115
∅ (mm)	∅ 11 x 5	∅ 11 x 5	∅ 11 x 5	∅ 11 x 5	∅ 11 x 5	∅ 11 x 5	∅ 11 x 5	∅ 11 x 5	∅ 11 x 5	∅ 11 x 5
W (kg)	0,088	0,108	0,108	0,116	0,116	0,116	0,128	0,152	0,152	0,220

kovkarb.by

11 x 5

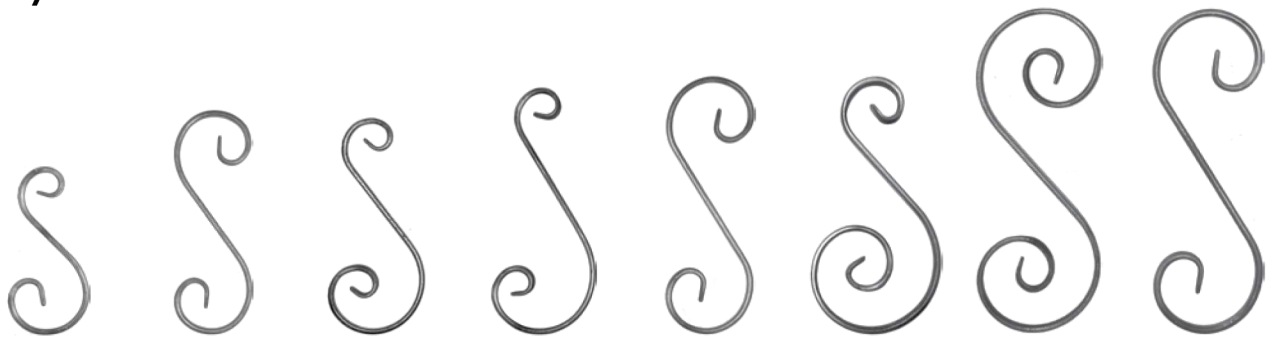

NR ART	01.070	01.070.05	01.071	01.071.01	01.071.05	01.072	01.072.01	01.072.05
H x L (mm)	150 x 70	200 x 70	195 x 80	220 x 90	230 x 80	230 x 115	290 x 115	290 x 110
∅ (mm)	∅ 11 x 5	∅ 11 x 5	∅ 11 x 5	∅ 11 x 5	∅ 11 x 5	∅ 11 x 5	∅ 11 x 5	∅ 11 x 5
W (kg)	0,136	0,180	0,172	0,180	0,220	0,260	0,344	0,260

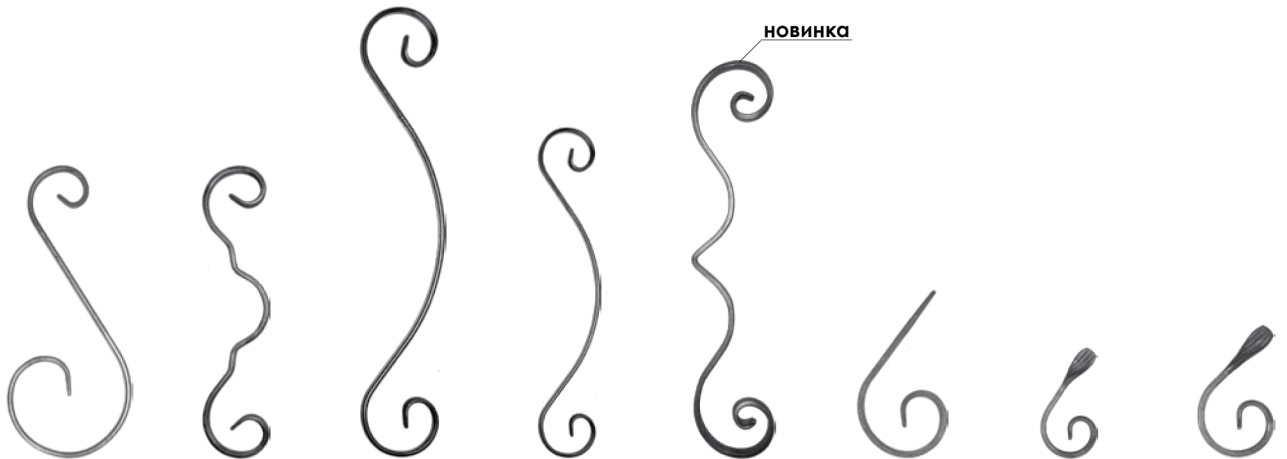

NR ART	01.073	01.075	01.076	01.076.01	01.076.02	01.077	01.078	01.079
H x L (mm)	260 x 110	250 x 60	450 x 85	350 x 70	430 x 90	150 x 80	100 x 60	120 x 70
∅ (mm)	∅ 11 x 5	∅ 11 x 5	∅ 11 x 5	∅ 11 x 5	∅ 11 x 5	∅ 11 x 5	∅ 11 x 5	∅ 11 x 5
W (kg)	0,228	0,180	0,305	0,220	0,300	0,128	0,088	0,108

12 x 6 полоса холоднокатаная



NR ART	01.092.02	01.092	01.093	01.093.01	01.094	01.095	01.096	01.097	01.097.02
H x L (mm)	80 x 50	95 x 60	100 x 60	110 x 65	115 x 70	120 x 70	130 x 70	150 x 80	160 x 80
∅ (mm)	∅ 12 x 6	∅ 12 x 6	∅ 12 x 6	∅ 12 x 6	∅ 12 x 6	∅ 12 x 6	∅ 12 x 6	∅ 12 x 6	∅ 12 x 6
W (kg)	0,124	0,153	0,153	0,164	0,181	0,181	0,181	0,215	0,215



NR ART	01.098.02	01.099.02	01.091.11	01.091.19	01.100	01.100.05	01.101	01.101.05	01.102
H x L (mm)	220 x 115	270 x 130	195 x 80	230 x 80	150 x 70	200 x 70	230 x 110	290 x 110	260 x 110
∅ (mm)	∅ 12 x 6	∅ 12 x 6	∅ 12 x 6	∅ 12 x 6	∅ 12 x 6	∅ 12 x 6	∅ 12 x 6	∅ 12 x 6	∅ 12 x 6
W (kg)	0,311	0,367	0,254	0,328	0,215	0,254	0,367	0,490	0,320

 12 x 6 полоса холоднокатаная

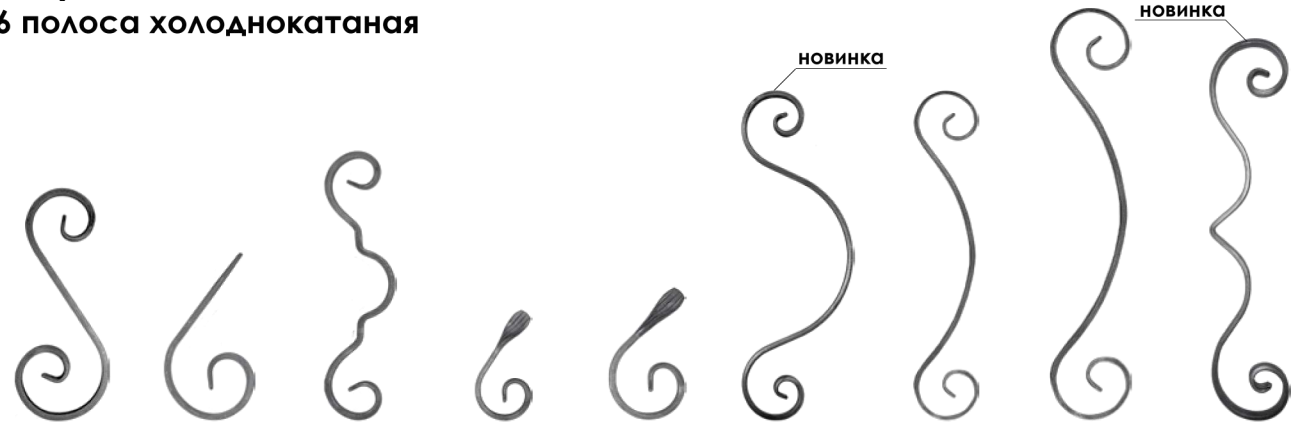



NOBINKA

NOBINKA

NR ART	01.103	01.083.27	01.105	01.108	01.109	01.113	01.114	01.114.28	01.117
H x L (mm)	225 x 90	150 x 80	250 x 75	100 x 65	120 x 80	390 x 135	350 x 70	450 x 80	430 x 90
∅ (mm)	∅ 12 x 6	∅ 12 x 6	∅ 12 x 6	∅ 12 x 6	∅ 12 x 6	∅ 12 x 6	∅ 12 x 6	∅ 12 x 6	∅ 12 x 6
W (kg)	0,320	0,180	0,255	0,135	0,155	0,420	0,320	0,470	0,420

 12 x 6

NR ART	01.092.02 W	01.092 W	01.093 W	01.093.01 W	01.094 W	01.095 W	01.096 W	01.096.04 W	01.097 W
H x L (mm)	80 x 50	95 x 60	100 x 60	110 x 65	115 x 70	120 x 70	130 x 70	140 x 110	150 x 80
∅ (mm)	∅ 12 x 6	∅ 12 x 6	∅ 12 x 6	∅ 12 x 6	∅ 12 x 6	∅ 12 x 6	∅ 12 x 6	∅ 12 x 6	∅ 12 x 6
W (kg)	0,124	0,153	0,153	0,164	0,181	0,181	0,181	0,300	0,215

NR ART	01.097.02 W	01.097.04 W	01.098.02 W	01.098.04 W	01.098.05 W	01.099.02 W	01.099.05 W
H x L (mm)	160 x 80	180 x 130	220 x 115	220 x 170	210 x 140	270 x 130	290 x 175
∅ (mm)	∅ 12 x 6	∅ 12 x 6	∅ 12 x 6	∅ 12 x 6	∅ 12 x 6	∅ 12 x 6	∅ 12 x 6
W (kg)	0,215	0,380	0,311	0,480	0,373	0,367	0,470

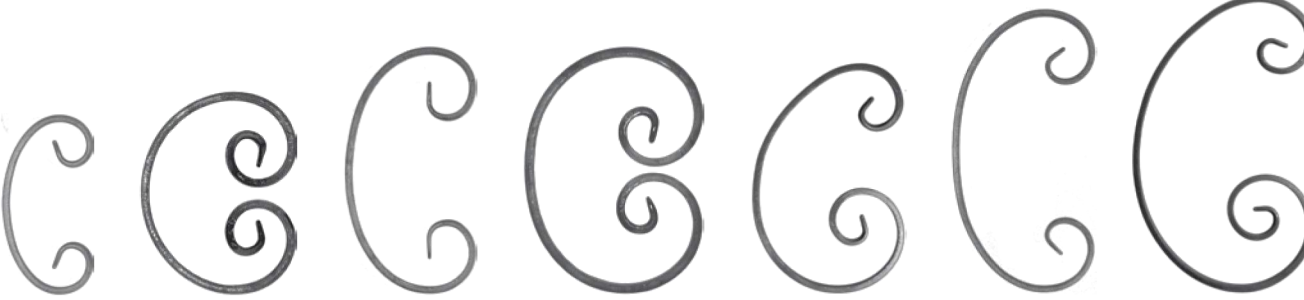
NOBINKA

NR ART	01.091.11 W	01.091.19 W	01.100 W	01.100.05 W	01.101 W	01.101.05 W	01.102 W	01.103 W	01.104 W
H x L (mm)	195 x 80	230 x 80	150 x 70	200 x 70	230 x 110	290 x 110	260 x 110	225 x 90	410 x 185
∅ (mm)	∅ 12 x 6	∅ 12 x 6	∅ 12 x 6	∅ 12 x 6	∅ 12 x 6	∅ 12 x 6	∅ 12 x 6	∅ 12 x 6	∅ 12 x 6
W (kg)	0,254	0,328	0,215	0,254	0,367	0,490	0,320	0,320	0,580

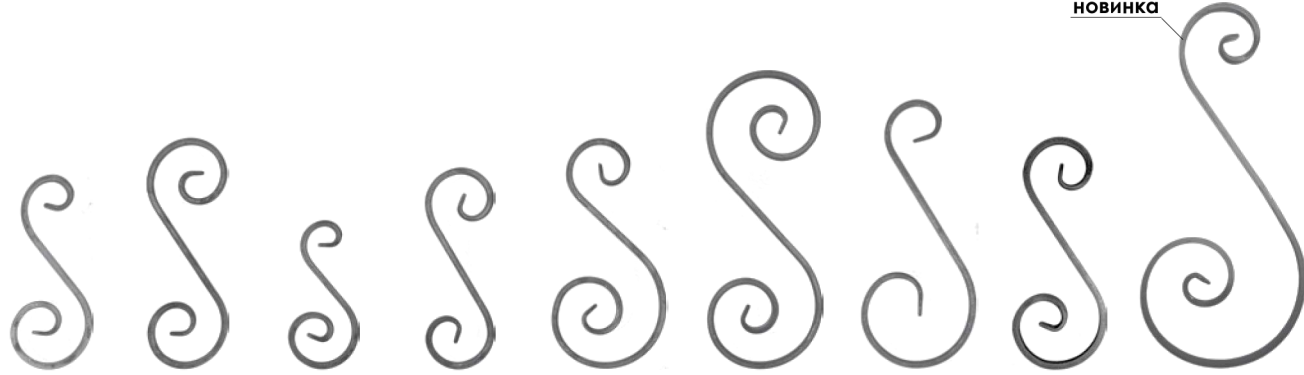
□ 12 x 6



NR ART	01.083.27 W	01.105 W	01.108 W	01.109 W	01.114 W	01.114.28 W	01.115 W	01.118 W
H x L (mm)	150 x 80	250 x 75	100 x 65	120 x 80	350 x 70	450 x 80	480 x 105	400 x 100
□ (mm)	□ 12 x 6	□ 12 x 6	□ 12 x 6	□ 12 x 6	□ 12 x 6	□ 12 x 6	□ 12 x 6	□ 12 x 6
W (kg)	0,180	0,255	0,135	0,155	0,320	0,470	0,470	0,440



NR ART	01.121	01.121.01	01.121.02
H x L (mm)	320 x 80	220 x 80	220 x 80
□ (mm)	□ 12 x 6	□ 12 x 6	□ 12 x 6
W (kg)	0,280	0,245	0,245



NR ART	01.135	01.137	01.138	01.139	01.140	01.140.05	01.141	01.141.05
H x L (mm)	120 x 65	150 x 95	200 x 125	255 x 115	160 x 75	190 x 75	200 x 85	220 x 85
□ (mm)	□ 12 x 6	□ 12 x 6	□ 12 x 6	□ 12 x 6	□ 12 x 6	□ 12 x 6	□ 12 x 6	□ 12 x 6
W (kg)	0,190	0,250	0,320	0,340	0,220	0,300	0,260	0,320

□ 10 X 10



NR ART	01.293	01.295	01.296	01.297	01.298	01.298.04	01.299
H x L (mm)	100 x 65	120 x 70	130 x 75	150 x 85	180 x 95	180 x 130	220 x 125
□ (mm)	□ 10 x 10	□ 10 x 10	□ 10 x 10	□ 10 x 10	□ 10 x 10	□ 10 x 10	□ 10 x 10
W (kg)	0,215	0,235	0,260	0,300	0,330	0,560	0,480

□ 10 X 10



NR ART	01.299.04	01.310	01.310.05	01.311	01.311.05	01.312	01.312.05
H x L (mm)	230 x 170	180 x 85	220 x 85	250 x 100	300 x 100	290 x 120	360 x 120
□ (mm)	□ 10 x 10	□ 10 x 10	□ 10 x 10	□ 10 x 10	□ 10 x 10	□ 10 x 10	□ 10 x 10
W (kg)	0,700	0,330	0,420	0,420	0,560	0,515	0,680

□ 10 X 10



NR ART	01.315	01.319	01.319.01	01.320	01.320.01	01.327	01.328
H x L (mm)	290 x 75	120 x 65	120 x 65	150 x 80	150 x 80	395 x 85	450 x 90
□ (mm)	□ 10 x 10	□ 10 x 10	□ 10 x 10	□ 10 x 10	□ 10 x 10	□ 10 x 10	□ 10 x 10
W (kg)	0,370	0,180	0,180	0,235	0,235	0,560	0,610

□ 12 X 12



NR ART	01.395	01.396	01.397	01.397.04	01.398	01.398.02	01.398.04
H x L (mm)	120 x 75	130 x 75	150 x 90	180 x 130	180 x 95	220 x 130	230 x 180
□ (mm)	□ 12 x 12	□ 12 x 12	□ 12 x 12	□ 12 x 12	□ 12 x 12	□ 12 x 12	□ 12 x 12
W (kg)	0,365	0,385	0,420	0,740	0,465	0,680	0,960



NR ART	01.399	01.400	01.400.05	01.401	01.401.05	01.402	01.402.05	01.404
H x L (mm)	360 x 145	180 x 90	220 x 90	250 x 105	300 x 100	290 x 120	360 x 120	410 x 200
□ (mm)	□ 12 x 12	□ 12 x 12	□ 12 x 12	□ 12 x 12	□ 12 x 12	□ 12 x 12	□ 12 x 12	□ 12 x 12
W (kg)	0,740	0,465	0,520	0,590	0,790	0,725	0,970	



NR ART	01.404.05	01.405	01.409	01.409.01	01.410	01.410.01	01.414	01.414.28
H x L (mm)	500 x 200	290 x 70	130 x 65	130 x 65	170 x 90	170 x 90	395 x 85	450 x 90
□ (mm)	□ 12 x 12	□ 12 x 12	□ 12 x 12	□ 12 x 12	□ 12 x 12	□ 12 x 12	□ 12 x 12	□ 12 x 12
W (kg)	1,680	0,520	0,245	0,245	0,340	0,340	0,790	0,860



NR ART	φ (mm)	□ (mm)	W (kg)
02.010.08	φ 80	□ 10 x 10	0,180
02.010.10	φ 100	□ 10 x 10	0,230
02.010.12	φ 120	□ 10 x 10	0,280
02.016	φ 100	□ 12 x 12	0,320
02.017	φ 120	□ 12 x 12	0,390
02.018.08	φ 100	□ 14 x 14	0,430
02.018.11	φ 120	□ 14 x 14	0,580

NR ART	φ (mm)	□ (mm)	W (kg)
02.025	φ 50	□ 12 x 6	0,080
02.026	φ 60	□ 12 x 6	0,980
02.028	φ 80	□ 12 x 6	0,130
02.031	φ 100	□ 12 x 6	0,160
02.032	φ 120	□ 12 x 6	0,200
02.033	φ 130	□ 12 x 6	0,220
02.035.03	φ 105	□ 12 x 6	0,180
02.035.04	φ 110	□ 12 x 6	0,190



NR ART	φ (mm)	□ (mm)	W (kg)
02.065.01	φ 100	□ 12 x 6	0,190
02.065.02	φ 120	□ 12 x 6	0,230

NR ART	H x L (mm)	□ / □ (mm)	W (kg)
02.126.80	80 x 80	□ 12 x 6	0,170
02.126.100	100 x 100	□ 12 x 6	0,215
02.126.120	120 x 120	□ 12 x 6	0,260
02.210.80	80 x 80	□ 10 x 10	0,230
02.210.100	100 x 100	□ 10 x 10	0,290
02.210.120	120 x 120	□ 10 x 10	0,360
02.212.100	100 x 100	□ 12 x 12	0,410
02.212.120	120 x 120	□ 12 x 12	0,500



NR ART	06.033	06.033.04	06.034	06.034.05
H x L (mm)	300 x 80	300 x 80	300 x 80	300 x 80
□ (mm)	□ 12 x 12	□ 12 x 12	□ 14 x 14	□ 14 x 14
W (kg)	0,420	0,440	0,560	0,580



NR ART	02.063.03	02.080	02.081	02.082	02.083	02.084	02.086	02.086.01	02.087
H x L (mm)	70 x 70	130 x 60	135 x 65	145 x 65	170 x 80	180 x 95	120 x 60	140 x 75	190 x 105
□ (mm)	□ 6 x 6	□ 12 x 12	□ 14 x 14	□ 16 x 16	□ 20 x 20	□ 24 x 24	□ 12 x 12	□ 15 x 15	□ 24 x 24
W (kg)	0,195	0,200	0,250	0,360	0,800	1,050	0,175	0,270	0,900



NR ART	H (mm)	L (mm)	□ (mm)	W (kg)
02.252.10	225	760	□ 12 x 6	1,820
02.252.11	225	760	□ 14 x 6	2,300
02.252.12	225	760	□ 20 x 6	3,300



NR ART	H (mm)	L (mm)	□ (mm)	W (kg)
02.252.20	330	1100	□ 12 x 6	3,160
02.252.21	330	1100	□ 14 x 6	4,050
02.252.22	330	1100	□ 20 x 6	5,600



NR ART	02.301.01	02.301.02	02.301.03	02.301.04	02.301.05	02.301.06	02.301.07	02.301.08	02.301.09
H x L (mm)	150 x 75	210 x 125	240 x 170	170 x 120	170 x 120	260 x 180	260 x 180	270 x 200	270 x 200
□ / □ (mm)	□ 12 x 6	□ 12 x 6	□ 12 x 12	□ 12 x 12	□ 12 x 12	□ 12 x 12	□ 12 x 12	□ 12 x 12	□ 12 x 12
W (kg)	0,160	0,260	0,720	0,400	0,400	0,980	0,980	1,080	1,080



NR ART	02.301.10	02.301.11	02.301.12	02.301.13	02.301.14	02.301.15
H x L (mm)	360 x 280	360 x 280	600 x 420	600 x 420	410 x 340	410 x 340
□ (mm)	□ 12 x 12	□ 12 x 12	□ 12 x 12	□ 12 x 12	□ 12 x 12	□ 12 x 12
W (kg)	1,480	1,480	2,600	2,600	2,020	2,020



NR ART	02.301.16	02.301.17	02.301.18	02.301.19	02.301.20
H x L (mm)	490 x 410	490 x 410	540 x 290	540 x 290	440 x 990
□ (mm)	□ 12 x12	□ 12 x12	□ 12 x12	□ 12 x12	□ 12 x12
W (kg)	2,960	2,960	1,900	1,900	3,900



NR ART	02.301.21	02.302.01	02.302.02	02.302.03	02.302.04
H x L (mm)	440 x 990	340 x 150	340 x 150	500 x 320	500 x 320
□ (mm)	□ 12 x12	□ 12 x12	□ 12 x12	□ 12 x12	□ 12 x12
W (kg)	3,900	0,920	0,920	1,980	1,980



NR ART	02.302.05	02.302.06	02.302.07	02.302.08
H x L (mm)	610 x 300	610 x 300	470 x 820	470 x 820
□ (mm)	□ 12 x12	□ 12 x12	□ 12 x12	□ 12 x12
W (kg)	2,640	2,640	3,350	3,350

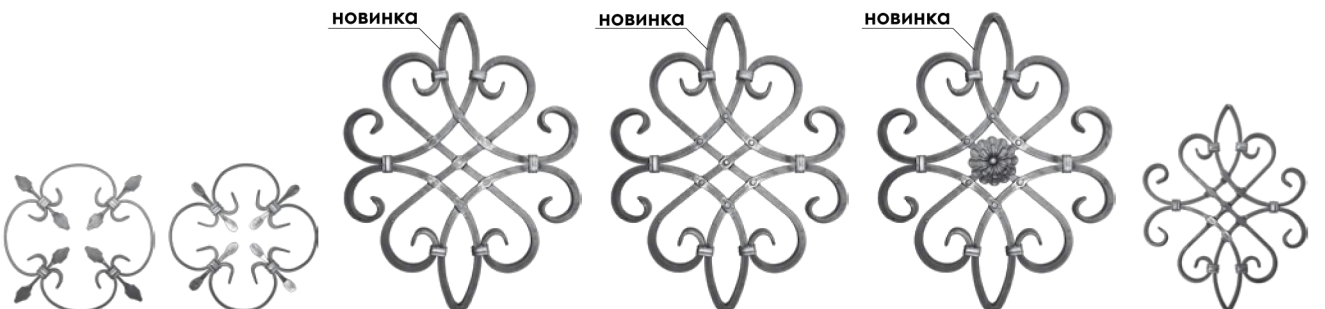

NR ART	03.005	03.007	03.010	03.012.10	03.012.12	03.018
H x L (mm)	250 x 250	250 x 250	530 x 420	530 x 420	530 x 420	340 x 280
□ / □ (mm)	□ 20 x4	□ 11 x 5	□ 10 x10	□ 12 x12	□ 12 x12	□ 12 x 6
W (kg)	1,000	0,700	3,650	4,380	4,840	1,480

НОВИНКА

НОВИНКА

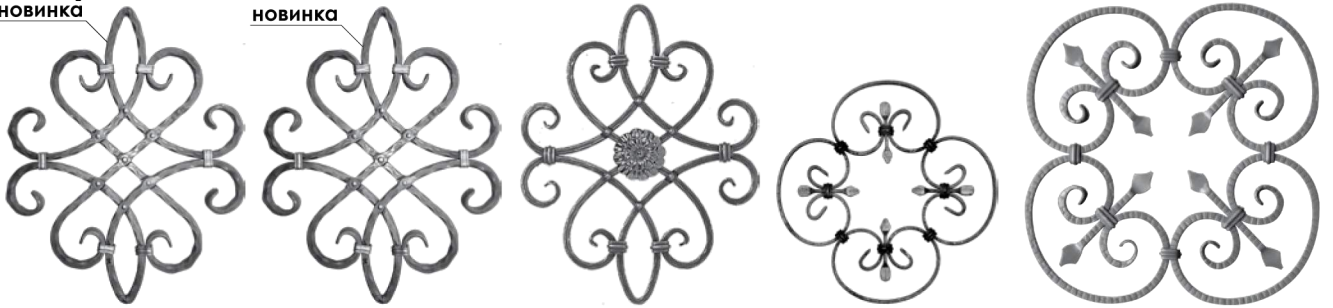

NR ART	03.016	03.018.10	03.018.12	03.020	03.025
H x L (mm)	530 x 420	530 x 420	530 x 420	380 x 380	590 x 590
□ / □ (mm)	□ 10 x 10	□ 12 x 12	□ 12 x 12	□ 10 x 5	□ 12 x 12
W (kg)	3,650	4,340	4,800	1,320	5,750

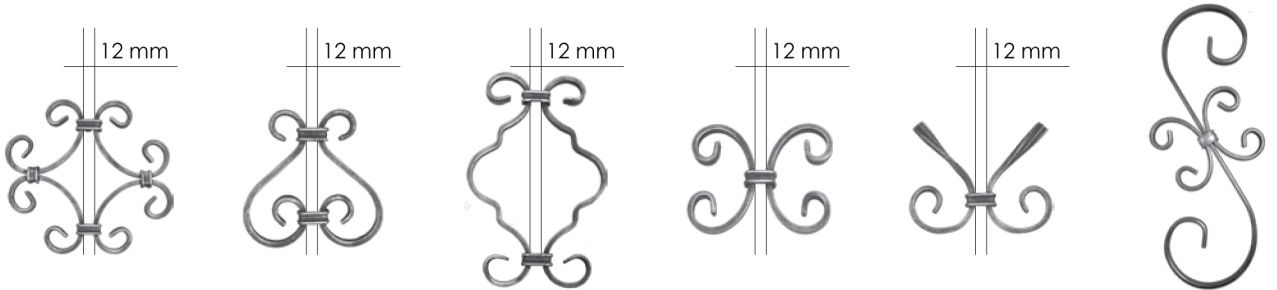

NR ART	03.027	03.043.01	03.051	03.052	03.109	03.142
H x L (mm)	210 x 220	150 x 150	250 x 160	120 x 150	120 x 170	340 x 135
□ / □ (mm)	□ 12 x 6	□ 12 x 6	□ 12 x 6	□ 12 x 6	□ 12 x 6	□ 11 x 5
W (kg)	0,800	0,450	0,480	0,380	0,300	0,520



NR ART	03.248	03.301.09	03.301.79	03.301.80	03.302.12
H x L (mm)	710 x 650	500 x 280	∅ 250 x 290	∅ 385 x 450	490 x 330
□ / □ (mm)	□ 16 x 8	□ 12 x 12	□ 12 x 12	□ 12 x 12	□ 12 x 12
W (kg)	6,900	2,140	1,200	2,900	3,580



NR ART	03.302.62	03.303.05	03.303.06	03.304.05	03.304.06
H x L (mm)	540 x 385	430 x 250	∅ 380	355 x 250	440 x 385
□ / □ (mm)	□ 12 x 12	□ 12 x 12	□ 12 x 12	□ 12 x 12	□ 12 x 12
W (kg)	4,520	2,000	3,900	1,740	3,500



NR ART	03.305.03	03.305.04	03.306.05	03.306.06
H x L (mm)	420 x 385	460 x 385	∅ 380	445 x 385
□ (mm)	□ 12 x 12	□ 12 x 12	□ 12 x 12	□ 12 x 12
W (kg)	3,850	3,600	4,150	4,300

НОВИНКА

НОВИНКА



NR ART	03.306.11	03.306.12	03.307.11	03.307.61	03.308.15
H x L (mm)	430 x 250	550 x 385	490 x 330	485 x 385	400 x 450
□ (mm)	□ 12 x 12	□ 12 x 12	□ 12 x 12	□ 12 x 12	□ 12 x 12
W (kg)	2,500	4,500	2,380	4,640	3,000



NR ART	03.309.11	03.309.12	03.309.13	03.310.07
H x L (mm)	525 x 250	∅ 385	545 x 385	450 x 250
□ (mm)	□ 12 x 12	□ 12 x 12	□ 12 x 12	□ 12 x 12
W (kg)	2,480	3,600	5,220	2,380



NR ART	03.311.05	03.311.06	03.312.06	03.312.07
H x L (mm)	290 x 300	480 x 400	300 x 330	390 x 510
□ (mm)	□ 12 x 12	□ 12 x 12	□ 12 x 12	□ 12 x 12
W (kg)	1,680	3,280	1,700	2,820



NR ART	03.312.08	03.312.09	03.312.14	03.312.15
H x L (mm)	290 x 340	450 x 475	260 x 270	260 x 270
□ (mm)	□ 12 x 12	□ 12 x 12	□ 12 x 12	□ 12 x 12
W (kg)	1,500	2,760	1,580	1,580

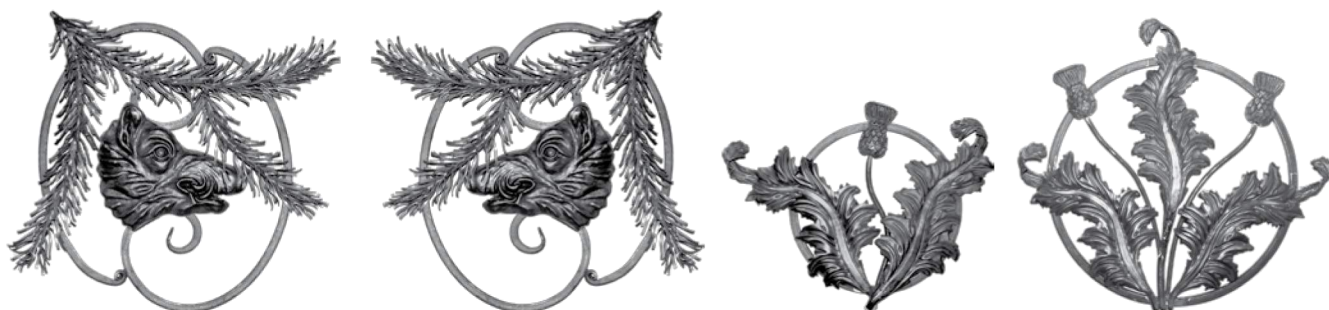

NR ART	03.312.16	03.312.17	03.313.04	03.313.05
H x L (mm)	470 x 520	470 x 520	310 x 390	440 x 480
□ (mm)	□ 12 x 12	□ 12 x 12	□ 12 x 12	□ 12 x 12
W (kg)	3,740	3,740	1,700	2,840



NR ART	03.313.54	03.313.55	03.313.56	03.314.09
H x L (mm)	310 x 250	400 x 320	490 x 385	400 x 340
□ (mm)	□ 12 x 12	□ 12 x 12	□ 12 x 12	□ 12 x 12
W (kg)	2,200	2,700	3,700	2,380



NR ART	03.315.06	03.316.06	03.316.07	03.317.06
H x L (mm)	350 x 290	420 x 385	440 x 385	500 x 300
□ (mm)	□ 12 x 12	□ 12 x 12	□ 12 x 12	□ 12 x 12
W (kg)	2,380	4,080	3,490	2,840

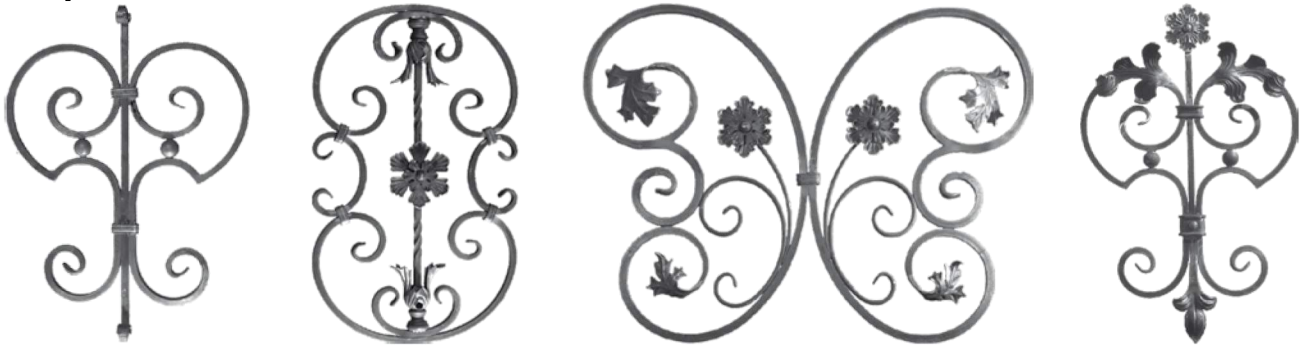

NR ART	03.316.02	03.316.03	03.316.04	03.316.05
H x L (mm)	560 x 405	610 x 370	510 x 675	640 x 405
□ (mm)	□ 12 x 12	□ 12 x 12	□ 12 x 12	□ 12 x 12
W (kg)	3,960	5,780	6,060	4,720

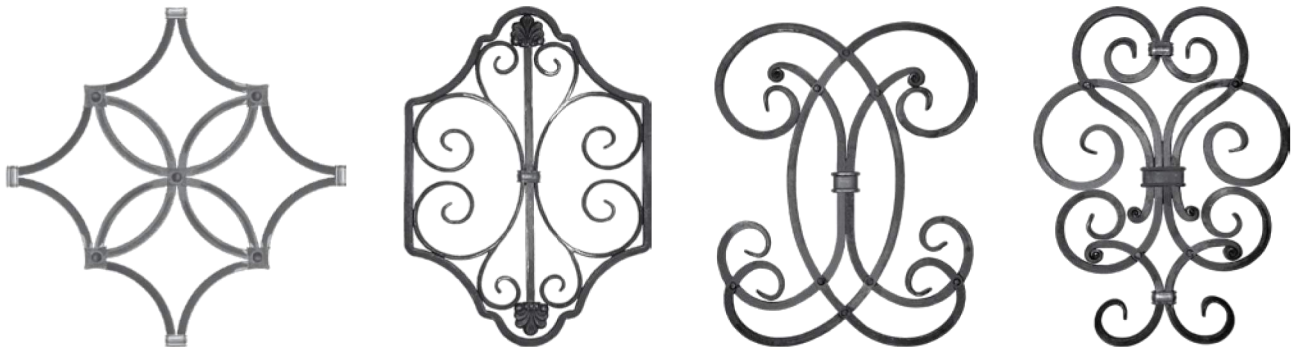

NR ART	03.316.08	03.316.10	03.316.17	03.316.18
H x L (mm)	516 x 516	535 x 385	470 x 385	500 x 385
□ (mm)	□ 12 x 12	□ 12 x 12	□ 12 x 12	□ 12 x 12
W (kg)	3,820	3,820	4,600	5,200



NR ART	03.316.11	03.316.12	03.316.13	03.316.14	03.316.15	03.316.16
H x L (mm)	∅ 385 x 405	405 x 405	∅ 250 x 320	310 x 320	∅ 250 x 300	300 x 225
□ (mm)	□ 12 x 12		□ 12 x 12		□ 12 x 12	
W (kg)	2,900	1,500	1,800	1,000	1,400	0,600



NR ART	03.318.08	03.318.09	03.318.10	03.319.07	03.319.08
H x L (mm)	310 x 250	400 x 320	540 x 385	310 x 250	400 x 310
□ (mm)	□ 12 x 12	□ 12 x 12	□ 12 x 12	□ 12 x 12	□ 12 x 12
W (kg)	1,500	2,240	2,720	1,840	2,680



NR ART	03.319.09	03.400	03.400.01	03.401	03.401.01	03.512
H x L (mm)	490 x 385	420 x 145	280 x 110	420 x 145	280 x 110	210 x 210
□ (mm)	□ 12 x 12	□ 11 x 5	□ 11 x 5	□ 12 x 6	□ 12 x 6	◇ 14 x 14
W (kg)	3,120	0,640	0,480	0,920	0,620	1,350

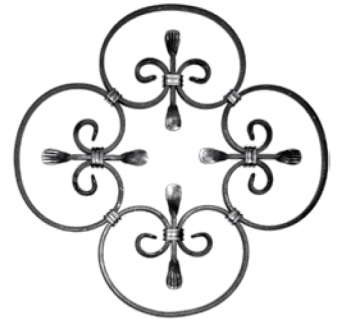
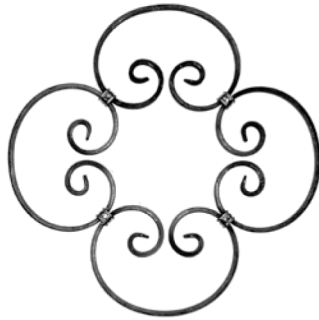

NR ART	03.406.14	03.406.15	03.406.16	03.406.17
H x L (mm)	265 x 265	310 x 310	265 x 265	310 x 310
□ (mm)	□ 12 x 6	□ 12 x 6	□ 12 x 6	□ 12 x 6
W (kg)	1,240	1,240	1,500	1,500
NR ART	03.407.18	03.407.19	03.407.20	03.407.21
H x L (mm)	335 x 335	385 x 385	335 x 335	385 x 385
□ (mm)	□ 12 x 6	□ 12 x 6	□ 12 x 6	□ 12 x 6
W (kg)	1,520	1,520	1,800	1,800
NR ART	03.408.22	03.408.23	03.408.24	03.408.25
H x L (mm)	400 x 400	470 x 470	400 x 400	470 x 470
□ (mm)	□ 12 x 6	□ 12 x 6	□ 12 x 6	□ 12 x 6
W (kg)	1,860	1,860	2,260	2,260

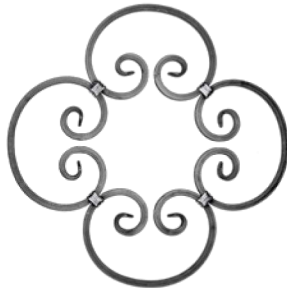

NR ART	03.410.18	03.410.19	03.410.20	03.410.21
H x L (mm)	325 x 325	380 x 380	325 x 325	380 x 380
□ (mm)	□ 10 x 10	□ 10 x 10	□ 10 x 10	□ 10 x 10
W (kg)	2,160	2,160	2,620	2,620
NR ART	03.411.22	03.411.23	03.411.24	03.411.25
H x L (mm)	420 x 420	490 x 490	420 x 420	490 x 490
□ (mm)	□ 10 x 10	□ 10 x 10	□ 10 x 10	□ 10 x 10
W (kg)	2,820	2,820	3,360	3,360



NR ART	03.412.18	03.412.19	03.412.20	03.412.21
H x L (mm)	325 x 325	380 x 380	325 x 325	380 x 380
□ (mm)	□ 12 x12	□ 12 x12	□ 12 x12	□ 12 x12
W (kg)	2,300	2,300	2,800	2,800
NR ART	03.413.22	03.413.23	03.413.24	03.413.25
H x L (mm)	420 x 420	490 x 490	420 x 420	490 x 490
□ (mm)	□ 12 x12	□ 12 x12	□ 12 x12	□ 12 x12
W (kg)	3,900	3,900	4,800	4,800



NR ART	03.413.26	03.413.27	03.413.28	03.413.29
H x L (mm)	420 x 420	430 x 430	500 x 500	430 x 430
□ (mm)	□ 12 x12	□ 12 x12	□ 12 x12	□ 12 x12
W (kg)	4,800	4,800	4,800	5,300

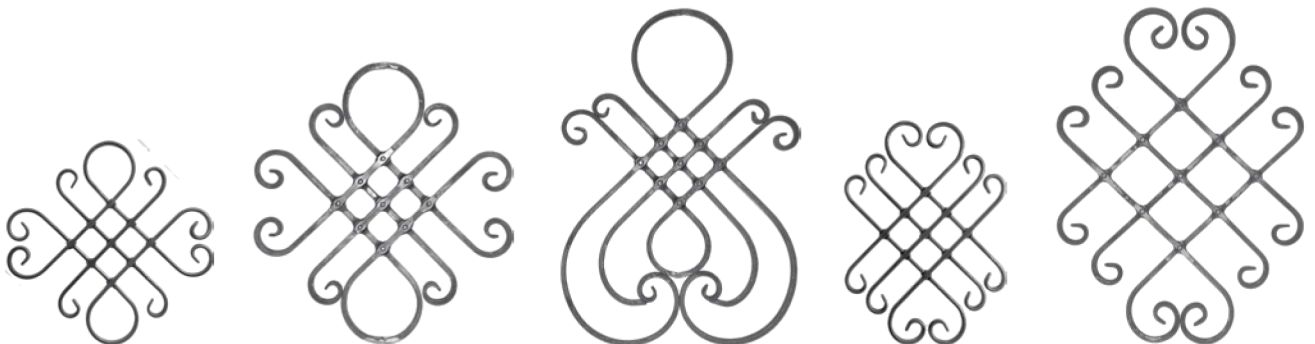

NR ART	03.570	03.571	03.574	03.580	03.581
H x L (mm)	290 x 290	400 x 410	575 x 400	300 x 220	440 - 580 x 380 - 620
□ / □ (mm)	□ 11 x 5	□ 16 x 8	□ 16 x 8	□ 11 x 5	□ 16 x 8
W (kg)	0,880	3,000	4,400	0,920	4,260



NR ART	03.603	03.605	03.607	03.608
H x L (mm)	680 x 420	680 x 420	680 x 290	680 x 290
□ / □ (mm)	□ 12 x 12	□ 12 x 12	□ 12 x 12	□ 12 x 12
W (kg)	3,250	3,380	3,800	3,800



НОВИНКА



НОВИНКА

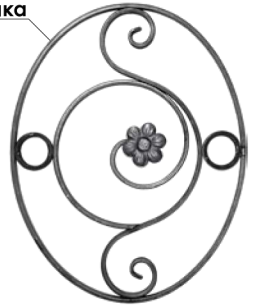

NR ART	03.610	03.611	03.618	03.620
H x L (mm)	370 x 300	370 x 300	400 x 310	400 x 310
□ / □ (mm)	□ 12 x 12 / □ 12 x 6	□ 12 x 12 / □ 12 x 6	□ 12 x 6	□ 12 x 6
W (kg)	1,800	1,800	2,060	1,560



NR ART	H x L (mm)	□ (mm)	W (kg)
03.700	765 x 890	□ 16 x 8	9,760

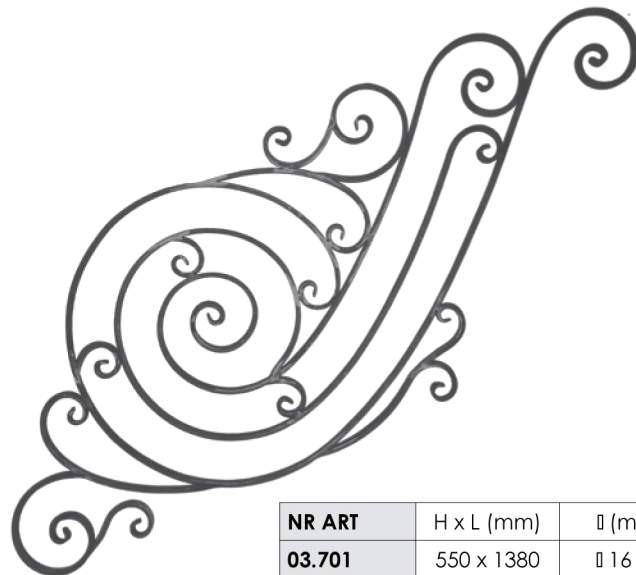

NR ART	H x L (mm)	□ (mm)	W (kg)
03.701	550 x 1380	□ 16 x 8	9,680

УЗОР ГРЕЧЕСКИ - ПРОДАЁТСЯ ТОЛЬКО КОМПЛЕКТОМ			
NR ART	H x L (mm)	G (mm)	W (kg)
03.800	100 x 920	6	2,160
ЭЛ. ВНУТРЕННИЙ	100 x 920	6	2,160
ЭЛ. НАРУЖНЫЙ	130 x 940	6	2,920

NR ART	H x L (mm)	G (mm)	W (kg)
03.810	980 x 97	6	2,480

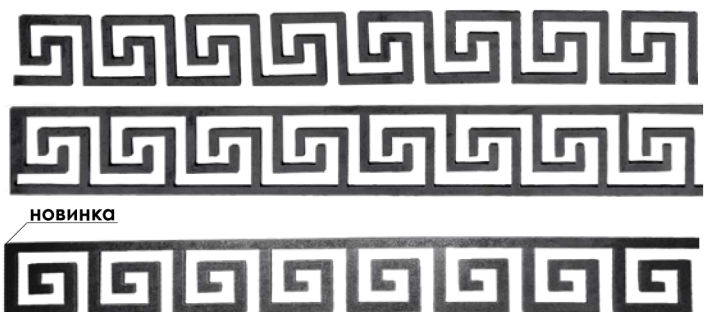

НОВИНКА



NR ART	04.002	04.003	04.004	04.006	04.007	04.008
H x L (mm)	200 x 60	200 x 60	200 x 60	360 x 65	360 x 65	360 x 65
□ (mm)-	□ 25 x 4	□ 30 x 4	□ 40 x 4	□ 25 x 4	□ 30 x 4	□ 40 x 4
W (kg)	0,304	0,365	0,495	0,420	0,495	0,67



NR ART	04.010	04.010.01	04.011	04.011.01	04.012	04.012.01	04.014	04.016
H x L (mm)	900 x 155	900 x 155	900 x 155	900 x 155	900 x 155	900 x 155	800 x 135	800 x 135
□ (mm)	□ 25 x 4	□ 25 x 4	□ 30 x 4	□ 30 x 4	□ 40 x 4	□ 40 x 4	□ 25 x 4	□ 40 x 4
W (kg)	1,060	1,440	1,280	1,720	1,650	2,200	1,000	1,500

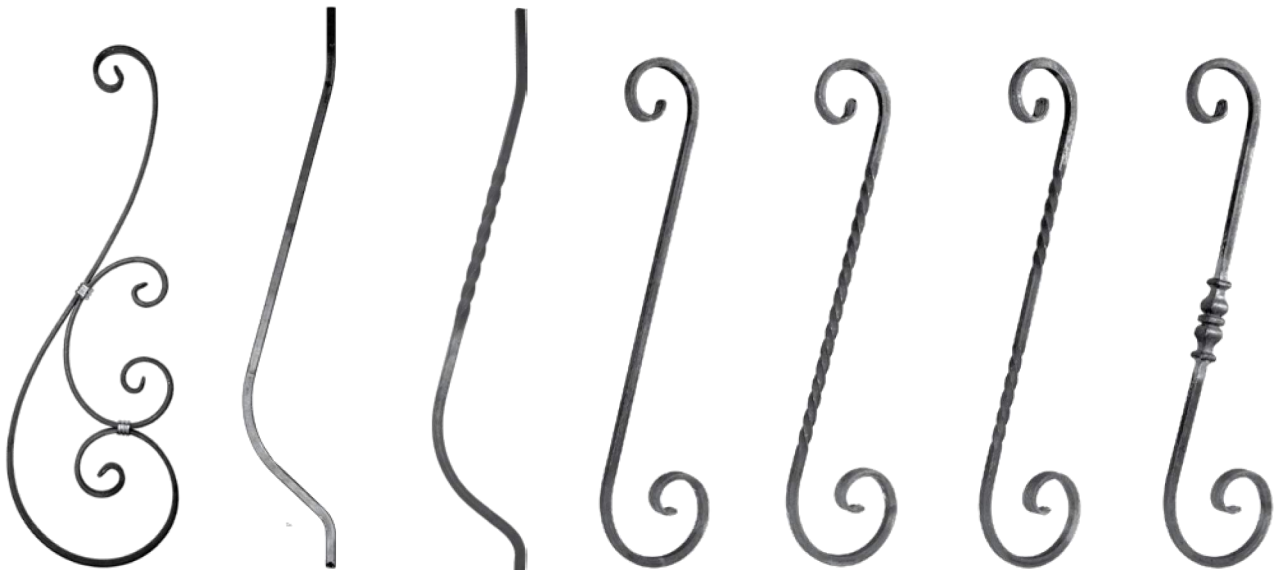

NR ART	04.025	04.040	04.045	04.057.01	04.057.02	04.057.03	04.057.04
□ / □ (mm)	□ 20 x 5	□ 12 x 12	□ 12 x 12	□ 12 x 12	□ 12 x 12	□ 12 x 12	□ 12 x 12
H x L (mm)	730 x 235	790 x 120	790 x 120	750 x 200	750 x 200	750 x 200	750 x 200
W (kg)	2,080	0,970	0,970	2,000	2,000	2,000	2,380

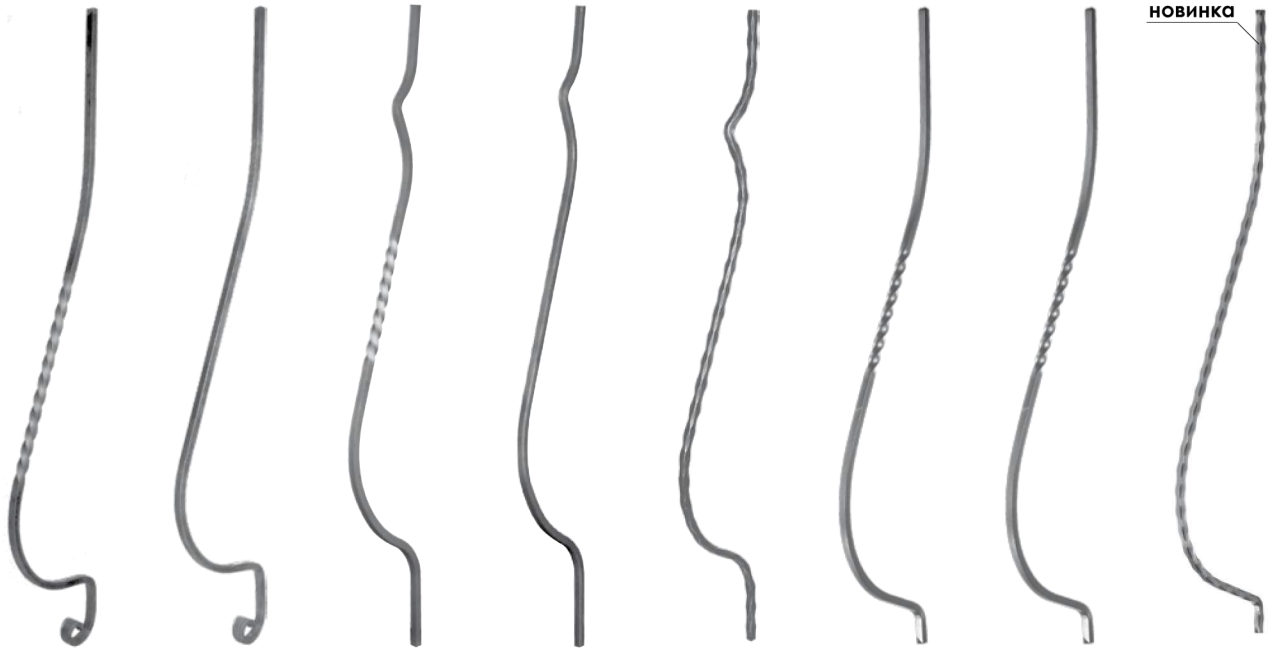

NR ART	04.060	04.070	04.075	04.083	04.090.09	04.098	04.098.25	04.102
□ / □ (mm)	□ 12 x 12	□ 12 x 12	□ 12 x 12	□ 12 x 12	□ 12 x 12	□ 10 x 10	□ 12 x 12	□ 10 x 10
H x L (mm)	950 x 200	950 x 200	950 x 125	950 x 125	950 x 125	950 x 200	950 x 200	950 x 200
W (kg)	1,360	1,360	1,150	1,150	1,000	0,760	1,200	0,880
NR ART			04.079	04.087	04.090.13		04.098.29	
□ / □ (mm)			□ 14 x 14	□ 14 x 14	□ 14 x 14		□ 14 x 14	
H x L (mm)			950 x 125	950 x 125	950 x 125		950 x 200	
W (kg)			1,600	1,600	1,450		1,700	

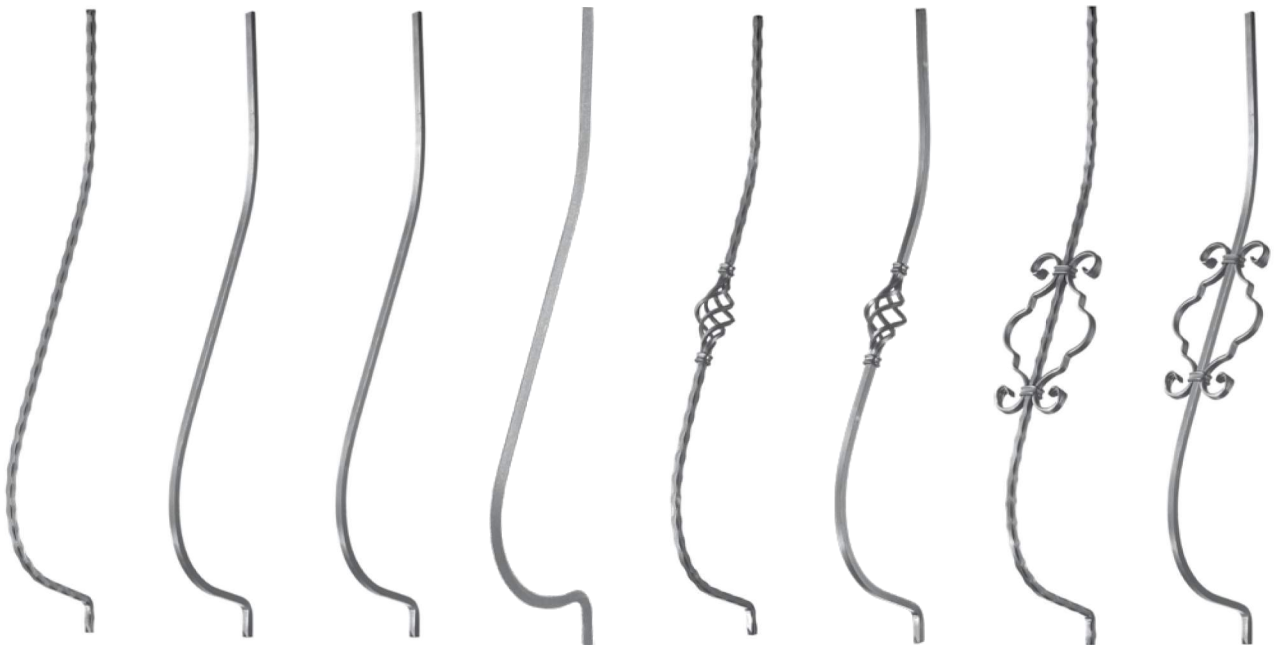

NR ART	04.103	04.106.04	04.106.05	04.106.25	04.107	04.110.05	04.111	04.114.05
□ (mm)	□ 12 x 12	□ 10 x 10	□ 12 x 12	◇ 12 x 12	□ 12 x 12	□ 12 x 12	□ 12 x 12	□ 12 x 12
H x L (mm)	950 x 200	950 x 200	950 x 200	950 x 200	950 x 200	950 x 200	950 x 200	950 x 200
W (kg)	1,120	0,760	1,200	1,200	1,440	1,240	1,700	1,705
NR ART	04.106.01		04.106.09	04.106.29	04.110.01	04.110.09	04.114.01	04.114.09
□ (mm)	□ 14 x 14		□ 14 x 14	◇ 14 x 14	□ 14 x 14	□ 14 x 14	□ 14 x 14	□ 14 x 14
H x L (mm)	950 x 200		950 x 200	950 x 200	950 x 200	950 x 200	950 x 200	950 x 200
W (kg)	1,700		1,750	1,750	1,750	1,700	2,350	2,350



NR ART	04.138	04.138.05	04.139	04.139.05	04.148	04.148.05	04.153	04.153.05
□ (mm)	□ 12 x 12	□ 12 x 12	□ 12 x 12	□ 12 x 12	□ 12 x 12	□ 12 x 12	□ 12 x 12	□ 12 x 12
H x L (mm)	950 x 200	950 x 200	950 x 200	950 x 200	950 x 200	950 x 200	950 x 200	950 x 200
W (kg)	1,500	1,600	1,450	1,500	1,650	1,750	1,700	1,800
NR ART	04.138.01	04.138.09	04.139.01	04.139.09	04.148.01	04.148.09	04.153.01	04.153.09
□ (mm)	□ 14 x 14	□ 14 x 14	□ 14 x 14	□ 14 x 14	□ 14 x 14	□ 14 x 14	□ 14 x 14	□ 14 x 14
H x L (mm)	950 x 200	950 x 200	950 x 200	950 x 200	950 x 200	950 x 200	950 x 200	950 x 200
W (kg)	2,100	2,200	2,000	2,050	1,750	2,250	2,200	2,300



NR ART	04.156	06.053	06.055	09.516.07	09.516.08	09.516.09	09.516.10
□ (mm)	◇ 14 x 14	□ 12 x 12	□ 12 x 12	□ 12 x 12	□ 12 x 12	□ 12 x 12	□ 12 x 12
H x L (mm)	950 x 200	950 x 200	950 x 125	950 x 125	950 x 200	950 x 125	950 x 200
W (kg)	2,600	1,150	1,100	1,200	1,200	1,200	1,200

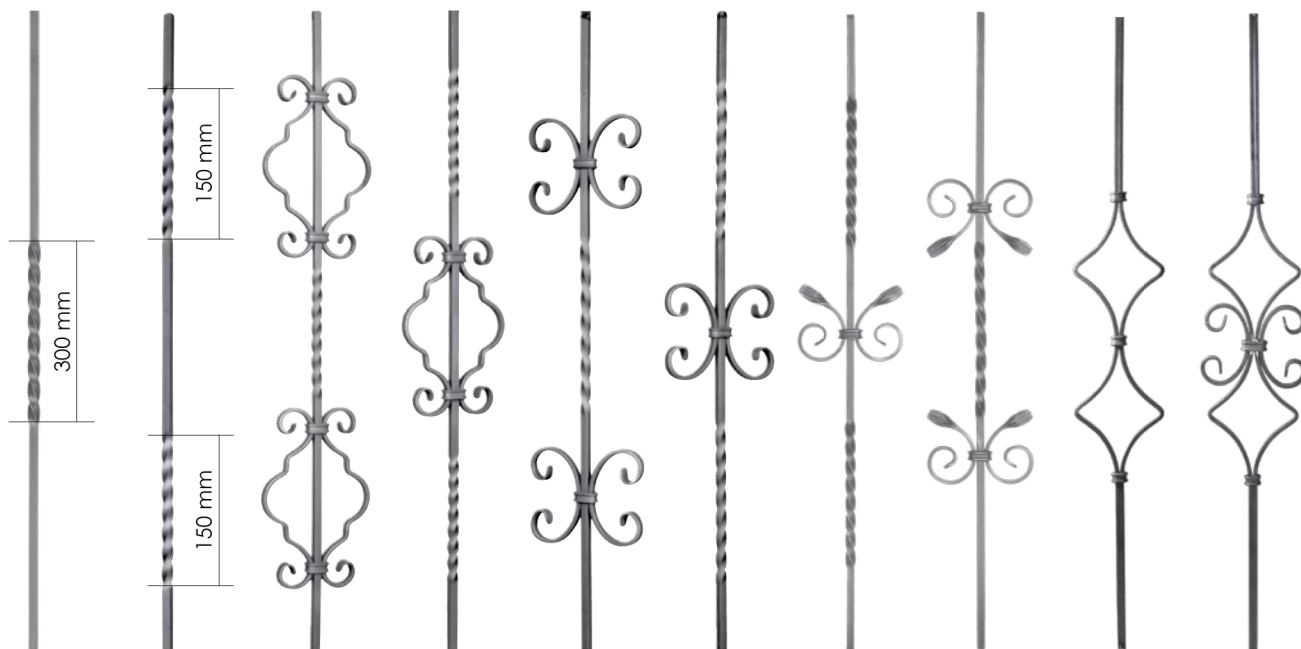

NR ART	05.045	05.046	05.065	05.066	05.067	05.068	05.071.01	05.071.03	05.072	05.073
□ (mm)	□ 12 x 12	□ 12 x 12	□ 12 x 12	□ 12 x 12	□ 12 x 12	□ 12 x 12	□ 12 x 12	□ 12 x 12	□ 12 x 12	□ 12 x 12
H x L (mm)	950	950	950 x 165	950 x 165	950 x 150	950 x 150	950 x 150	950 x 150	950 x 130	950 x 155
W (kg)	1,100	1,100	2,100	1,550	1,850	1,460	1,400	1,700	1,180	1,540
NR ART	05.045.01	05.046.01								
□ (mm)	□ 14 x 14	□ 14 x 14								
H x L (mm)	950	950								
W (kg)	1,420	1,420								

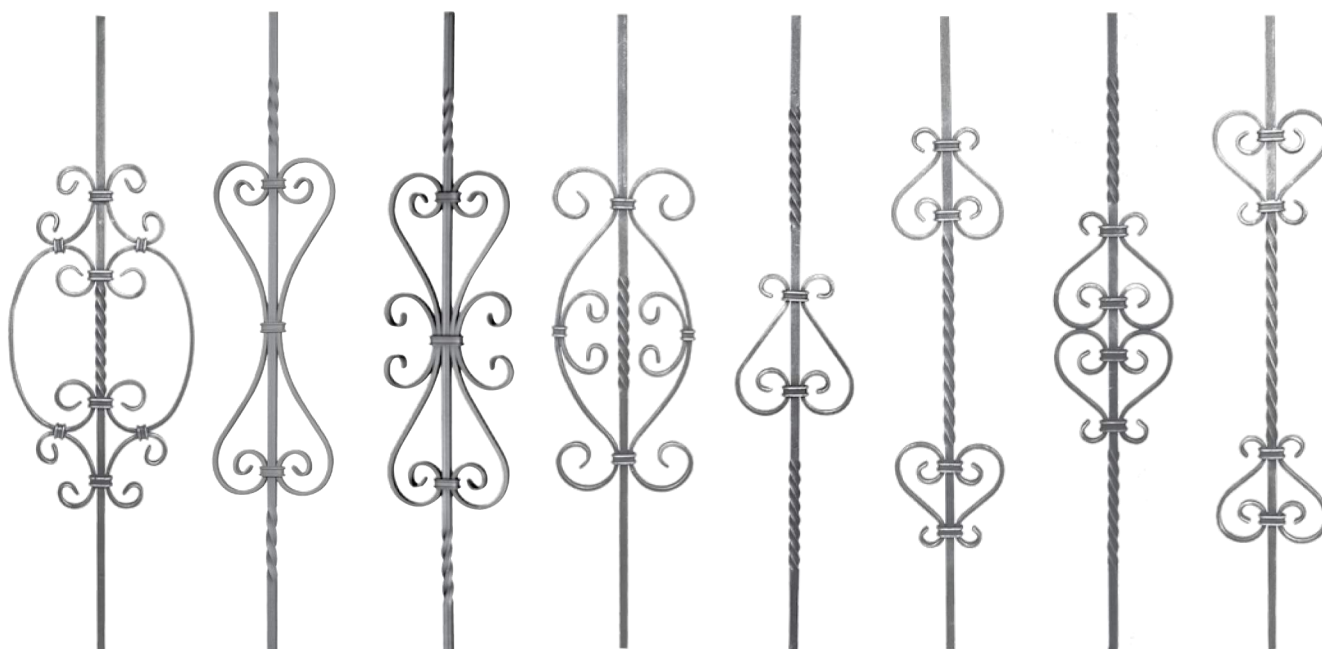

NR ART	05.074	05.075	05.076	05.076.01	05.077	05.077.01	05.077.02	05.077.03
□ (mm)	□ 12 x 12	□ 12 x 12	□ 12 x 12	□ 12 x 12	□ 12 x 12	□ 12 x 12	□ 12 x 12	□ 12 x 12
H x L (mm)	950 x 220	950 x 170	950 x 180	950 x 180	950 x 180	950 x 150	950 x 150	950 x 150
W (kg)	2,370	2,150	2,400	2,400	1,700	2,000	2,000	2,000

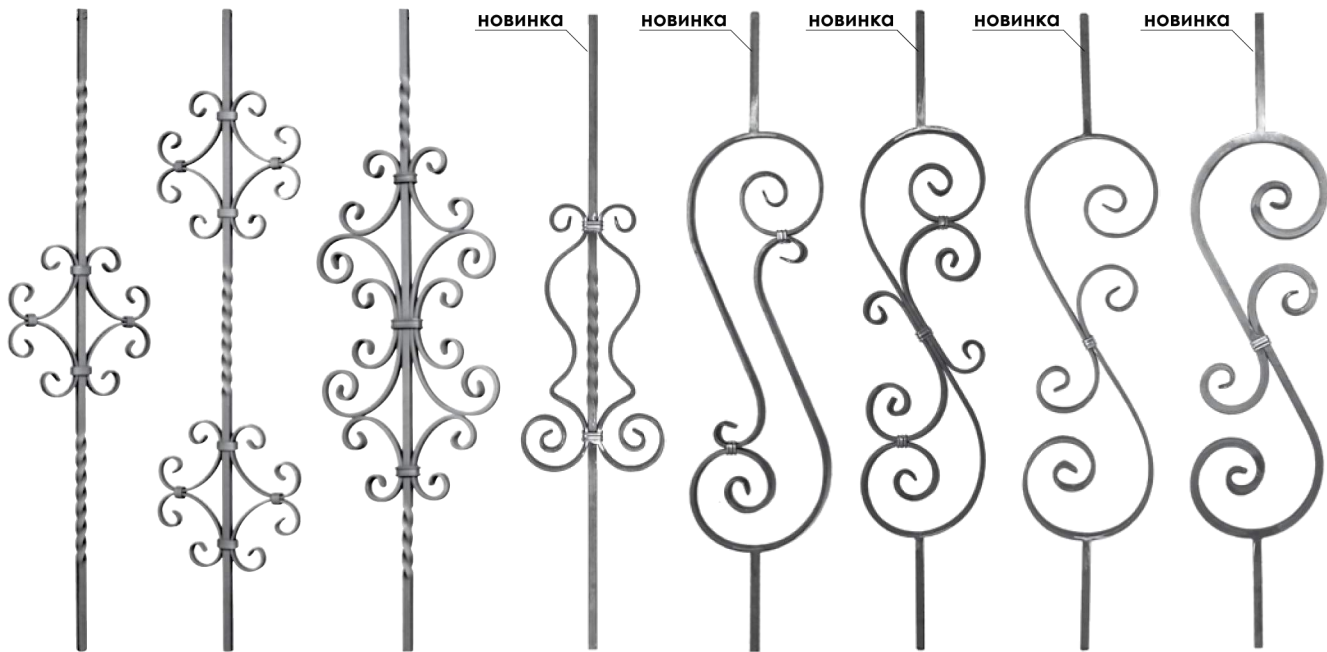

NR ART	05.083	05.084	05.085	05.087	05.090	05.091	05.092	05.100
□ (mm)	□ 12 x 12	□ 12 x 12	□ 12 x 12	□ 12 x 12	□ 12 x 12	□ 12 x 12	□ 12 x 12	□ 12 x 12
H x L (mm)	950 x 220	950 x 220	950 x 250	950 x 215	950 x 190	950 x 190	950 x 190	950 x 200
W (kg)	1,600	2,100	2,950	2,000	1,560	1,910	1,540	2,800



NR ART	05.105	05.108	05.123	05.124	05.124.02	05.124.04	05.130	05.131
□ (mm)	□ 12 x 12	□ 8 x 8	□ 12 x 12	□ 12 x 12	□ 12 x 12	□ 12 x 12	□ 12 x 12	□ 12 x 12
H x L (mm)	950 x 125	800 x 280	950	950	950	950	950 x 170	950 x 170
W (kg)	2,000	2,400	1,100	1,220	1,100	1,200	1,400	1,700
NR ART			05.123.01	05.124.01	05.124.03	05.124.05		
□ (mm)			□ 14 x 14	□ 14 x 14	□ 14 x 14	□ 14 x 14		
H x L (mm)			950	950	950	950		
W (kg)			1,600	1,650	1,500	1,650		



NR ART	05.142	05.211.17	05.211.19	05.426	05.429.01	05.429.02	05.429.03	05.429.04
□ (mm)	□ 12 x 6	□ 12 x 12	□ 12 x 12	∅ 40 x 2,0	∅ 30 x 1,5	∅ 30 x 1,5	∅ 30 x 1,5	∅ 30 x 1,5
H x L (mm)	860 x 350	900 x 200	900 x 200	1200	900	900	900	900
W (kg)	2,300	3,200	3,400	2,260	0,970	0,930	0,930	0,930



NR ART	05.432	05.433	05.434	05.435	05.434.01	05.435.01	06.008	06.009
□ (mm)	□ 12 x 12	□ 12 x 12	□ 12 x 12	□ 12 x 12	□ 12 x 12	□ 12 x 12	□ 12 x 12	□ 12 x 12
H x L (mm)	950	950	950	950	950	950	950	950
W (kg)	1,100	1,200	1,100	1,250	1,150	1,150	1,100	1,200
NR ART							06.008.01	06.009.01
□ (mm)							□ 14 x 14	□ 14 x 14
H x L (mm)							950	950
W (kg)							1,600	1,650



NR ART	06.040	06.050	06.051	06.052	07.019	07.301.10	07.301.11
φ/□ (mm)	□ 12 x 12	□ 12 x 12	□ 12 x 12	□ 12 x 12	□ 12 x 12	□ 16 x 16	φ 14
H x L (mm)	950 x 170	950 x 170	950 x 170	950 x 170	900 x 230	760 x 200	950 x 90
W (kg)	1,860	1,480	1,480	1,480	2,550	4,650	2,340
NR ART							07.301.12
□ (mm)							□ 12 x 12
H x L (mm)							950 x 90
W (kg)							2,340



NR ART	07.302.16	07.302.17	07.303.01	07.305.01	07.306.01	07.307.01	07.308.01
φ/□ (mm)	φ 14	φ 14	φ 14	φ 14	φ 14	φ 14	φ 14
H x L (mm)	900 x 270	950 x 200	950 x 275	950 x 165	950 x 250	950 x 180	950 x 180
W (kg)	3,420	2,540	2,200	1,930	2,900	2,220	2,280
NR ART		07.302.18	07.303.02	07.305.02	07.306.02		07.308.02
□ (mm)		□ 12 x 12	□ 12 x 12	□ 12 x 12	□ 12 x 12		□ 12 x 12
H x L (mm)		950 x 200	950 x 275	950 x 165	950 x 250		950 x 180
W (kg)		2,540	2,200	1,930	2,900		2,280



NR ART	07.309.01	07.310.01	07.310.06	07.311.01	07.313.01	
φ/□ (mm)	φ14	φ14		φ14	φ14	
H x L (mm)	950 x 195	950 x 200	1070 x 520	950 x 180	950 x 180	
W (kg)	2,300	2,700	7,000	2,340	1,740	
NR ART	07.309.02	07.310.02		07.311.02	07.313.02	07.313.12
□ (mm)	□ 12 x 12	□ 12 x 12		□ 12 x 12	□ 12 x 12	□ 12 x 12
H x L (mm)	950 x 195	950 x 200		950 x 180	950 x 180	950 x 250
W (kg)	2,300	2,700		2,340	1,600	3,700



NR ART	07.314.10	07.317.01	07.318.01	07.319.01	07.380	07.802
φ/□ (mm)		φ14	φ14	φ14	□ 12 x 12	□ 14 x 8
H x L (mm)	815 x 485	950 x 250	950 x 210	950 x 200	950 x 155	1000 x 190
W (kg)	3,270	2,520	2,040	2,200	1,700	3,350
NR ART		07.317.02	07.318.02	07.319.02		
□ (mm)		□ 12 x 12	□ 12 x 12	□ 12 x 12		
H x L (mm)		950 x 250	950 x 210	950 x 200		
W (kg)		2,520	2,040	2,200		



NR ART	09.154.12	09.154.13	09.211	09.220	09.509	09.510	09.510.03	09.510.04	09.516.01	09.516.02
□ / φ (mm)	φ 10 x 2	φ 10 x 2	□ 12 x 12	□ 12 x 12	φ 14	φ 14	□ 14 x 14	□ 14 x 14	□ 12 x 12	□ 12 x 12
H (mm)	1000	1000	900	900	950	950	950	950	1000	1000
W (kg)	1,900	2,100	1,030	1,030	1,180	1,260	1,550	1,700	1,200	1,100

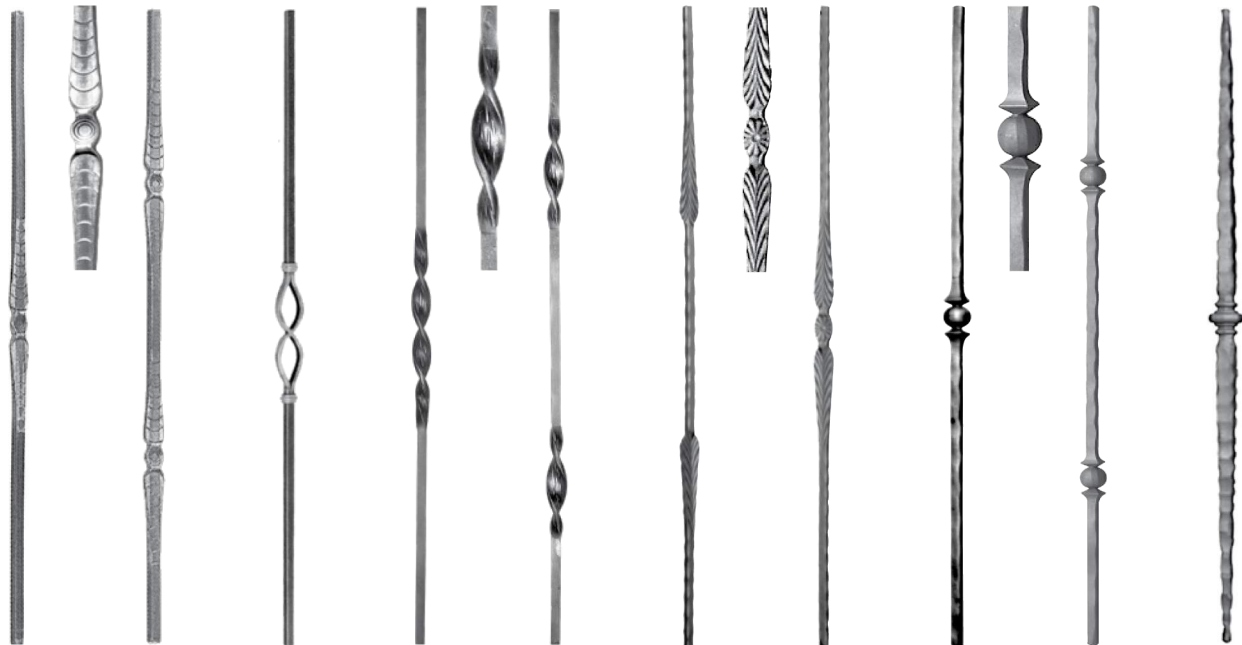

NR ART	09.516.03	09.516.04	09.535	09.626	09.628	09.632	09.633	11.002	11.003	11.012
□ / □ (mm)	□ 12 x 12	□ 12 x 12	□ 12 x 12	□ 12 x 12	□ 12 x 12	□ 12 x 12	□ 12 x 12	□ 14 x 14	□ 14 x 14	□ 14/20
H (mm)	1000	1000	1000	950	950	950	950	950	950	950
W (kg)	1,200	1,100	1,200	1,030	1,030	1,080	1,080	1,350	1,640	1,960



NR ART	11.011.01	11.011.02	11.017.01	11.017.02	11.032	11.033	11.036	11.037	11.038	11.039
φ/□ (mm)	□ 14 x 14	□ 14 x 14	φ12	φ12	□ 14 x 14	□ 14 x 14	□ 14 x 14	□ 14 x 14	□ 14 x 14	□ 14 x 14
H (mm)	1000	1000	1000	1000	1000	1000	950	950	1000	1000
W (kg)	1,250	1,640	1,050	1,250	1,600	1,480	1,580	1,900	1,450	1,600



NR ART	11.048	11.053.21	11.053.30	11.054	11.055	11.057	11.059	11.061	11.061.12
□ (mm)	□ 25 x 25	□ 25 x 25	φ 25	□ 25 x 25	□ 25 x 25	□ 25 x 25	□ 25 x 25	□ 25 x 25	□ 25 x 25
H (mm)	1200	1200	1200	1200	1200	1200	1200	1200	1200
W (kg)	5,900	5,800	5,200	7,460	4,750	6,740	5,600	5,600	6,000



NR ART	11.064.16	11.070	11.071	11.312.02	11.312.03	11.312.05	11.312.06
φ / □ (mm)	φ 50	□ 25 x 25	□ 25 x 25	□ 30 x 30	□ 30 x 30		
H (mm)	1300	1200	1200	1000	1000	960	960
W (kg)	8,000	5,900	5,900	9,500	9,100	18,300	22,000

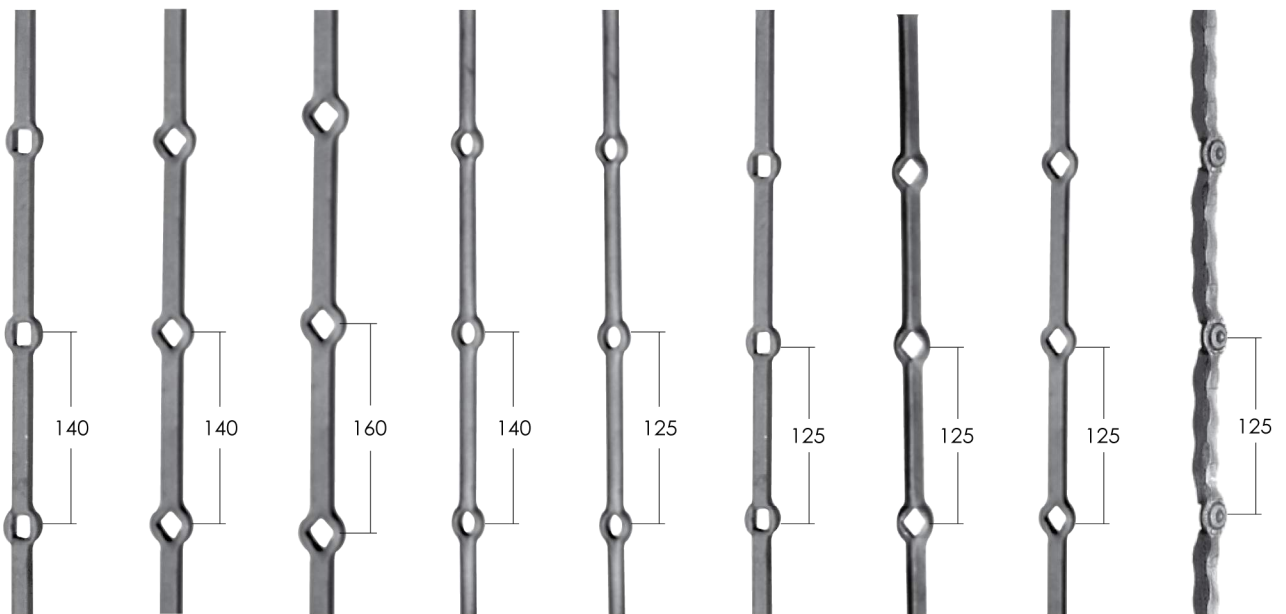

NR ART	08.001	08.013	08.015	08.023	08.115	08.119	08.123	08.127	08.105
□ (mm)	□ 14 x 14	□ 14 x 14	□ 18 x 18	φ 14 x 14	φ 14 x 14	□ 14 x 14	◇ 14 x 14	□ 14 x 14	□ 14 x 14
H (mm)	2000	2000	2000	2000	2000	2000	2000	2000	2000
Otw.	□ 14 / 14 otw.	◇ 14 / 14 otw.	◇ 18 / 12 otw.	φ 14 / 14 otw.	φ 14 / 15 otw.	□ 14 / 15 otw.	◇ 14 / 14 otw.	◇ 14 / 14 otw.	
W (kg)	3,080	3,080	5,080	2,420	2,420	3,080	3,080	3,080	2,780



NR ART	12.005	12.017	12.018.01	12.021	12.025	12.028
□ (mm)	□ 40 x 8	□ 40 x 8	□ 40 x 8	□ 40 x 8	□ 40 x 8	□ 40 x 8
H x L (mm)	3000	350 x 100	300 x 180	600	300 x 300	200 x 200
W (kg)	7,500	1,200	1,500	2,000	1,500	1,050



NR ART	12.029	12.032	12.032.01	12.034	12.035	12.036
□ (mm)	□ 40 x 8	□ 40 x 8	□ 40 x 8	□ 40 x 8	□ 40 x 8	□ 40 x 8
H x L (mm)	3000	350 x 100	300 x 180	600	300 x 300	200 x 200
W (kg)	7,500	1,200	1,500	2,000	1,500	1,050

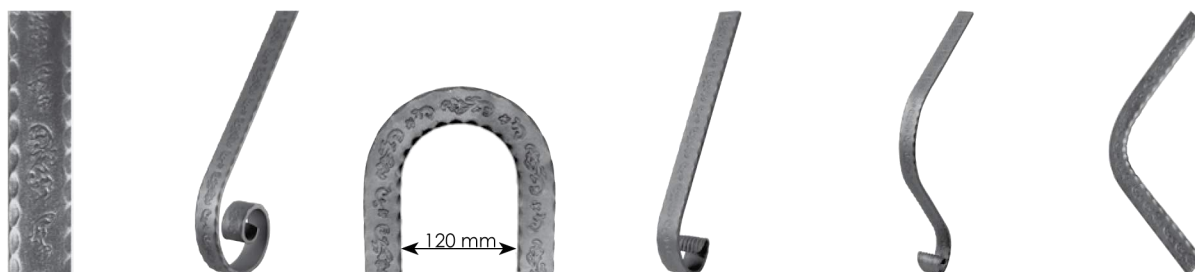



NR ART	12.038	12.040.01	12.041	12.042.01	12.043.01	12.044
□ (mm)	□ 40 x 8	□ 40 x 8	□ 40 x 8	□ 40 x 8	□ 40 x 8	□ 40 x 8
H x L (mm)	3000	300 x 180	200 x 200	350 x 100	600	300 x 300
W (kg)	7,500	1,500	1,050	1,200	2,000	1,500





NR ART	12.045	12.046.01	12.047	12.047.01	12.048.01	12.049
□ (mm)	□ 40 x 8	□ 40 x 8	□ 40 x 8	□ 40 x 8	□ 40 x 8	□ 40 x 8
H x L (mm)	3000	300 x 180	350 x 100	300 x 300	600	200 x 200
W (kg)	7,500	1,500	1,200	1,500	2,000	1,050





NR ART	12.053	12.053.01	12.055	12.056	12.056.01	12.057.02	12.058.01
H x L (mm)	3000	400	300 x 300	300 x 100	300 x 170	600	200 x 200
	40 x 10	40 x 10	40 x 10	40 x 10	40 x 10	40 x 10	40 x 10
W (kg)	7,500	1,700	1,050	1,200	1,500	2,000	1,050
NR ART	12.054	12.054.01	12.055.01	12.057	12.057.01	12.058	12.058.02
	50 x 10	50 x 10	50 x 10	50 x 10	50 x 10	50 x 10	50 x 10
W (kg)	9,400	2,100	1,500	1,500	1,940	2,800	1,500



NR ART	12.063	12.068	12.072	12.076	12.078
H x L (mm)	3000	300 x 170	300 x 100	400	600
	40 x 8	40 x 8	40 x 8	40 x 8	40 x 8
W (kg)	5,600	1,400	0,960	1,200	1,700
NR ART	12.066	12.070	12.075	12.077	12.080
	50 x 10	50 x 10	50 x 10	50 x 10	50 x 10
W (kg)	9,200	1,800	1,560	1,980	2,750



NR ART	12.084	12.084.05	12.085.05	12.086	12.086.12	12.087	12.087.04
H x L (mm)	3000	300 x 300	200 x 200	400	300 x 100	300 x 170	600
	50 x 14	50 x 14	50 x 14	50 x 14	50 x 14	50 x 14	50 x 14
W (kg)	13,000	2,200	2,200	2,900	2,200	2,820	3,900
NR ART	12.084.01	12.084.06	12.085.06	12.086.01	12.086.13	12.087.01	12.087.05
	40 x 12	40 x 12	40 x 12	40 x 12	40 x 12	40 x 12	40 x 12
W (kg)	9,000	1,450	1,450	1,950	1,480	1,880	2,610



NR ART	12.001	12.096	12.108.01	12.108	12.110	12.114	12.118	12.131	12.141
□ (mm)	25 x 6	20 x 10	25 x 8	14 x 4	18 x 5	14 x 3	14 x 4	14 x 2	17 x 2
H (mm)	3000	3000	3000	4000	4000	3000	4000	1200	1200
W (kg)	3,500	4,500	3,500	1,650	2,000	0,860	1,300	0,220	0,260
NR ART	12.003	12.096.01	12.108.02	12.109	12.111	12.115	12.119	12.133	12.143
□ (mm)	30 x 6	12 x 6	30 x 8	18 x 5	14 x 4	16 x 4	16 x 5	14 x 2	17 x 2
H (mm)	3000	3000	3000	4000	4000	3000	4000	3000	3000
W (kg)	4,200	1,600	3,700	2,800	1,450	1,260	2,000	0,600	0,660
NR ART	12.006.10		12.108.05			12.116	12.120		
□ (mm)	40 x 6		40 x 8			20 x 4	21 x 6		
H (mm)	3000		3000			3000	4000		
W (kg)	5,650		4,450			1,570	3,000		

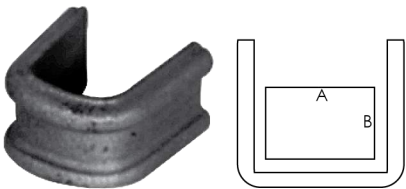

NR ART	□ (mm)	A x B (mm)	W (kg)
12.122.12	14 x 4	□ 12 x 12	0,032
12.122.14	14 x 4	□ 14 x 14	0,034
12.122.18	14 x 4	□ 18 x 12	0,038
12.122.24	14 x 4	□ 24 x 12	0,047



NR ART	□ (mm)	A x B (mm)	W (kg)
12.135.12	14 x 2	□ 12 x 12	0,011
12.135.14	14 x 2	□ 14 x 14	0,012
12.135.18	14 x 2	□ 18 x 12	0,013
12.135.24	14 x 2	□ 24 x 12	0,015



NR ART	H (mm)	□ (mm)	W (kg)
12.174	3000	□ 10 x 10	2,400
12.175	3000	□ 12 x 12	3,000
12.176	3000	□ 14 x 14	4,200
12.177	3000	□ 16 x 16	5,800



NR ART	H (mm)	φ (mm)	W (kg)
12.196.14	3000	φ 6	0,650
12.196.15	3000	φ 8	1,150
12.196.16	3000	φ 10	1,850
12.196.17	3000	φ 12	2,650
12.196.18	3000	φ 14	3,600
12.196.19	3000	φ 16	4,700
12.196.20	3000	φ 20	7,300
12.196.21	3000	φ 24	10,500

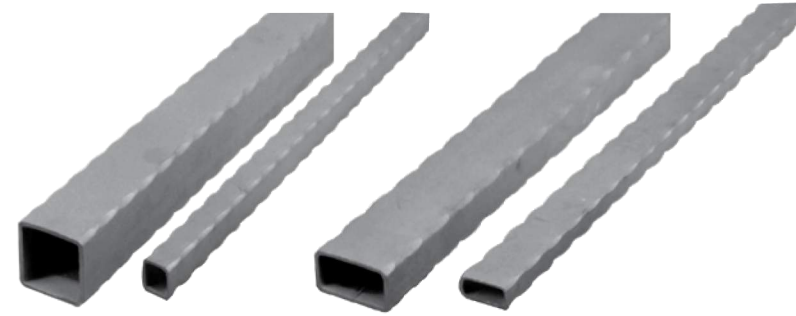

NR ART	H (mm)	□ (mm)	G (mm)	W (kg)
12.237	3000	□ 40 x 40	2,5	8,950
12.239	3000	□ 30 x 30	2,0	5,450
12.241	3000	□ 25 x 25	2,0	4,500
12.243	3000	□ 20 x 20	2,0	3,540
12.245	3000	□ 60 x 40	2,5	13,300
12.249	3000	□ 50 x 30	2,5	8,500
12.250.01	3000	□ 40 x 30	2,0	6,450
12.251	3000	□ 40 x 20	2,0	5,450
12.253	3000	□ 30 x 20	2,0	4,500

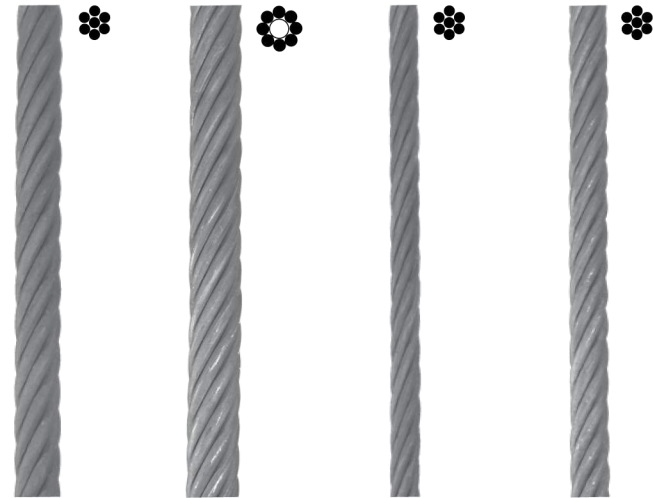

NR ART	H (mm)	φ (mm)	⊗	W (kg)
12.305.11	1000	φ 38	6 x φ12	6,650
12.305.12	2000	φ 38	6 x φ12	13,300
12.305.13	3000	φ 38	6 x φ12	19,950
12.305.21	1000	φ 47	8 x φ12	9,100
12.305.22	2000	φ 47	8 x φ12	18,200
12.305.23	3000	φ 47	8 x φ12	27,300
12.305.31	1000	φ 25	6 x φ 8	2,860
12.305.32	2000	φ 25	6 x φ 8	5,720
12.305.33	3000	φ 25	6 x φ 8	8,580
12.305.41	1000	φ 30	6 x φ10	4,720
12.305.42	2000	φ 30	6 x φ10	9,440
12.305.43	3000	φ 30	6 x φ10	14,160

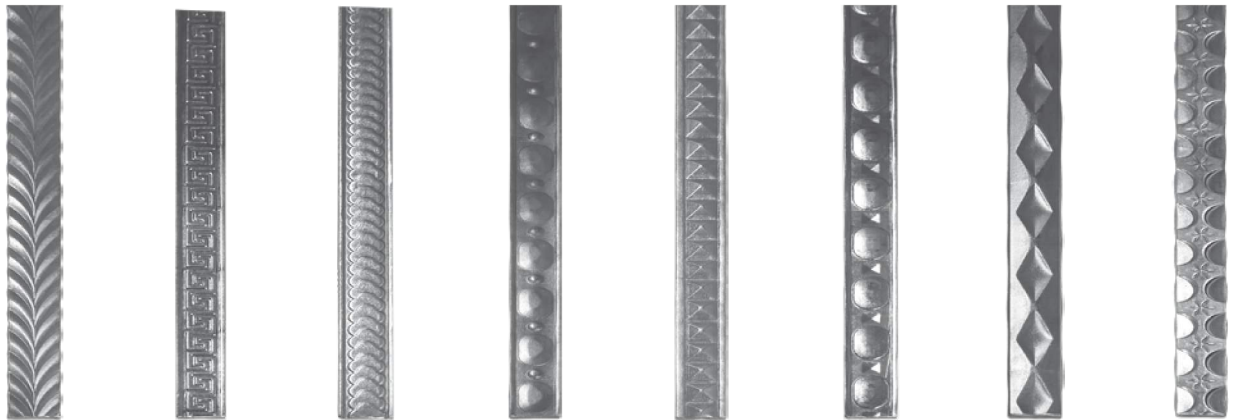

NR ART	12.341	12.342	12.343	12.344	12.345	12.346	12.348	12.349
□ (mm)	□ 32 x 5	□ 31 x 5	□ 31 x 5	□ 31 x 5	□ 32 x 9	□ 31 x 5	□ 32 x 9	□ 32 x 6
H (mm)	3000	3000	3000	3000	3000	3000	3000	3000
W (kg)	3,650	2,900	3,270	3,200	3,900	3,150	5,900	3,700

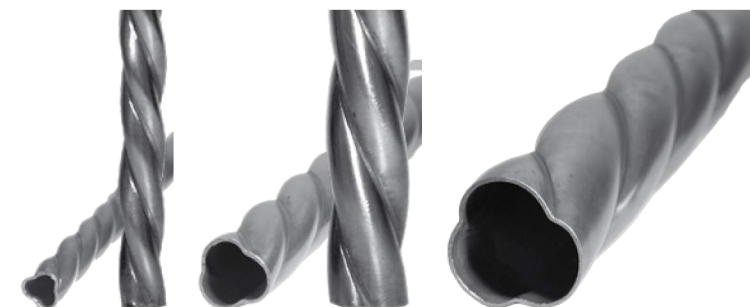

NR ART	H (mm)	φ (mm)	G (mm)	W (kg)
12.411.10	3000	φ 11	1,0	0,750
12.420.18	3000	φ 20	1,8	2,430
12.425.18	3000	φ 25	1,8	3,090
12.430.20	3000	φ 30	2,0	4,140
12.442.20	3000	φ 42	2,0	5,970
12.448.20	3000	φ 48	2,0	6,840
12.476.20	3000	φ 76	2,0	10,950



NR ART	13.041	13.042	13.045	13.046	13.047	13.048	13.048.01	13.049
H (mm)	125	155	130	160	200	110	76	135
L (mm)	60	70	50	65	85	60	43	70
φ (mm)	φ 13	φ 17	φ 13	φ 17	φ 20	φ 20	φ 16	φ 26
W (kg)	0,140	0,280	0,130	0,230	0,330	0,120	0,064	0,260

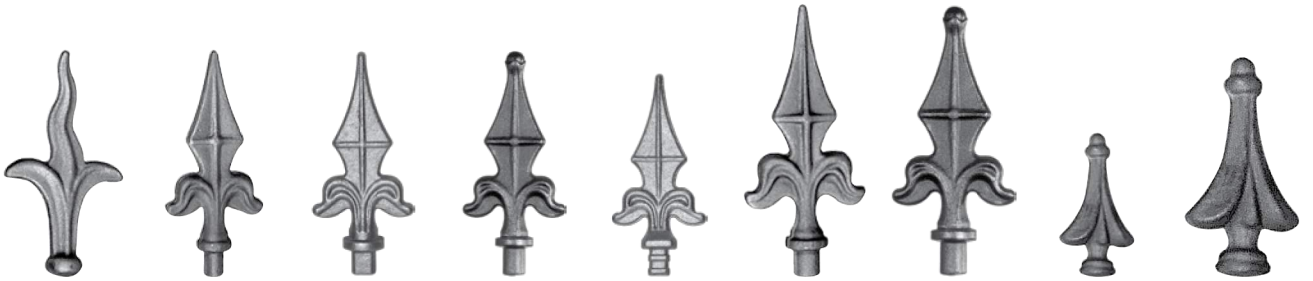

NR ART	13.050	13.052	13.052.01	13.052.02	13.052.03	13.053	13.053.02	13.055	13.056
H (mm)	130	130	130	130	115	155	155	80	125
L (mm)	70	60	60	60	53	70	70	45	65
φ (mm)	φ 20	φ 12	□ 15 x 15	φ 12	□ 12 x 12	φ 16	φ 16	φ 20	φ 25
W (kg)	0,130	0,160	0,140	0,180	0,100	0,260	0,285	0,135	0,360



NR ART	13.058	13.059	13.060	13.060.01	13.060.02	13.061	13.061.02	13.064.01	13.064.02
H (mm)	125	135	115	78	115	140	140	120	100
L (mm)	55	65	60	43	60	70	70	55	45
φ (mm)	φ 20	φ 25	φ 20	φ 16	φ 20	φ 26	φ 26	φ 14	φ 12
W (kg)	0,170	0,230	0,148	0,083	0,170	0,260	0,280	0,260	0,130

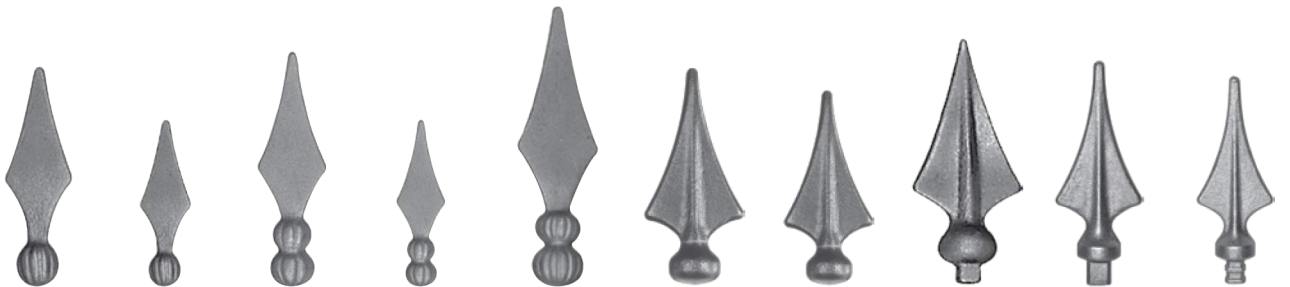

NR ART	13.071	13.071.01	13.072	13.072.01	13.073	13.077	13.077.01	13.078	13.078.01	13.078.02
H (mm)	125	95	135	95	160	125	110	140	130	120
L (mm)	40	30	40	33	50	60	50	60	50	43
φ (mm)	φ 25	φ 20	φ 25	φ 20	φ 30	φ 32	φ 25	□ 15	□ 15 x 15	□ 12 x 12
W (kg)	0,160	0,096	0,170	0,100	0,320	0,250	0,160	0,255	0,150	0,120



NR ART	13.079.01	13.080	13.080.02	13.080.06	13.088	13.089	13.092	13.092.01	13.093
H (mm)	100	155	145	130	110	160	125	82	160
L (mm)	50	65	58	70	20	25	30	20	40
φ / □ (mm)	□ 16 x 12	φ 16	φ 28	φ 20	□ 20	□ 25	□ 20	□ 15	□ 32
W (kg)	0,140	0,270	0,280	0,130	0,140	0,330	0,220	0,103	0,620



NR ART	13.094	13.095	13.097	13.098.01	13.098.02	13.098.03	13.099.01	13.099.02
H (mm)	190	95	60	150	120	88	120	155
L (mm)	50	27	30	40	35	28	65	90
φ / □ (mm)	□ 40	□ 12	□ 24	φ 33	φ 30	φ 24	□ 25	□ 30
W (kg)	1,130	0,180	0,200	0,400	0,220	0,115	0,230	0,700



NR ART	13.100	13.102	13.103.01	13.103.02	13.103.03	13.103.04	13.103.05	13.107
H (mm)	160	140	180	155	150	165	150	145
L (mm)	90	50	56	60	65	60	55	80
φ / □ (mm)	φ 16	φ 13	φ 14	□ 14 - 18	φ 16	φ 24	φ 15	□ 15
W (kg)	0,303	0,160	0,233	0,310	0,300	0,230	0,280	0,230

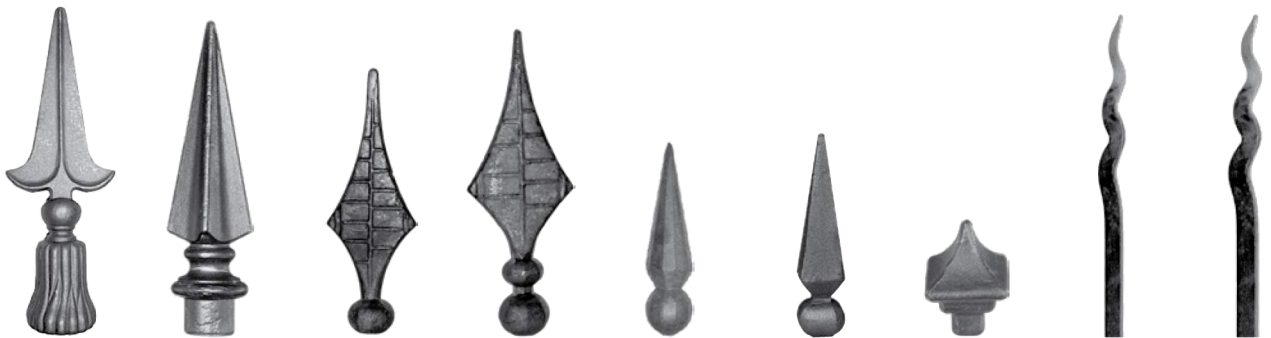

NR ART	13.110	13.111.01	13.117	13.118	13.127	13.128	13.218.01	13.222.07	13.222.08
H (mm)	235	210	180	205	130	135	57	250	250
L (mm)	80	58	60	65	33	30	38	□ 12	□ 14
φ / □ (mm)	φ 50	φ 32	φ 29	φ 35	φ 30	□ 30	□ 16	□ 12	□ 14
W (kg)	0,850	1,090	0,285	0,535	0,380	0,395	0,190	0,240	0,310



NR ART	13.401	13.407.01	13.407.02	13.407.03	13.410.01	13.410.02	13.411	13.411.01	13.413
H (mm)	120	142	112	87	152	180	120	120	120
L (mm)	48				∅ 36	∅ 41	40	40	42
∅ / □ (mm)	□ 16	□ 26	□ 20	□ 16	∅ 26	∅ 43	□ 12	□ 12	□ 14 - 18
W (kg)	0,170	0,320	0,160	0,080	0,310	0,600	0,100	0,090	0,108

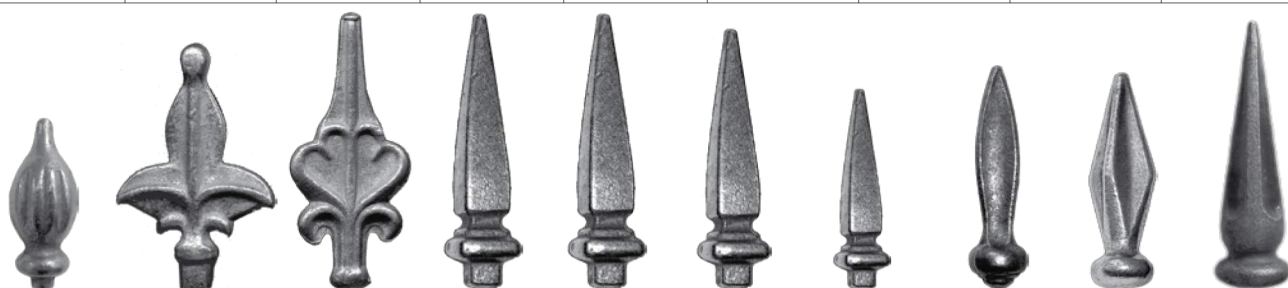

NR ART	13.414	13.416	13.419	13.421	13.421.01	13.421.02	13.421.03	13.424	13.427	13.433
H (mm)	92	132	155	148	148	142	107	118	117	145
L (mm)	∅ 36	86	70	36	36	28	26	35	36	
∅ / □ (mm)	∅ 12	∅ 16	∅ 24	□ 16	□ 20	□ 16	□ 16	∅ 32	∅ 32	∅ 35
W (kg)	0,360	0,300	0,360	0,480	0,480	0,340	0,200	0,310	0,34	0,430



NR ART	13.439	13.450	13.450.01	13.451	13.451.01	13.453	13.454	13.454.01	13.454.02
H (mm)	111	107	107	100	100	155	48	214	167
L (mm)	65	52	52	54	54	39	∅ 33	36	33
∅ / □ (mm)	∅ 14	∅ 28	∅ 28	∅ 16	∅ 16	∅ 36	∅ 20	□ 18	□ 18
W (kg)	0,190	0,200	0,220	0,280	0,300	0,420	0,160	0,680	0,450

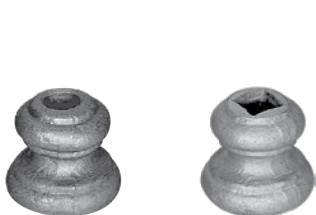

NR ART	H (mm)	L (mm)	∅ / □ (mm)	W (kg)
13.133	39	40	bez otw.	0,200
13.135	39	40	∅ 12,5	0,150
13.136	39	40	∅ 14,5	0,140
13.141	39	40	□ 12	0,140
13.150	44	45	□ 14	0,200

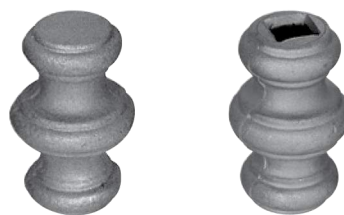

NR ART	H (mm)	L (mm)	∅ / □ (mm)	W (kg)
13.134	67	40	bez otw.	0,260
13.142	67	40	□ 12,5	0,180
13.147	67	45	∅ 14,5	0,300
13.152	67	45	□ 14,5	0,275
13.153	67	45	□ 16,5	0,240



NR ART	H (mm)	L (mm)	φ / □ (mm)	W (kg)
13.168	22	40	φ 14,5	0,140
13.169	22	40	□ 14,5	0,115
13.169.01	22	40	□ 16,5	0,100
13.169.02	22	40	□ 12,5	0,120



NR ART	H (mm)	L (mm)	φ / □ (mm)	W (kg)
13.169.03	22	33	□ 12,5	0,100
13.169.05	22	38	□ 14,5	0,160
13.169.06	22	38	□ 16,5	0,155
13.169.07	35	55	□ 20,5	0,345



NR ART	13.186.01	13.186.02	13.186.03	13.186.04	13.186.05	13.186.06	13.186.07	13.186.08	13.186.09	13.186.10
H (mm)	140	140	140	140	140	70	70	70	130	140
L (mm)	35	30	26	33	28	30	30	35	25	24
φ / □ (mm)	□ 20	□ 16	□ 12	φ 16-18	φ 12-14	φ 12-16	□ 12-14	□ 16-20	□ 14	φ 12
W (kg)	0,850	0,580	0,380	0,575	0,385	0,260	0,260	0,380	0,380	0,360



NR ART	13.214	13.217	13.217.01	13.218	13.219	13.220	13.227	13.229
H (mm)	90	90	150	180	80	100	130	120
φ / □ (mm)	φ 40	φ 50	φ 75	φ 100	φ 28	φ 50	φ 75	φ 75
W (kg)	0,500	0,780	3,060	6,350	0,410	0,900	1,880	1,890



NR ART	13.235.01	13.235.02	13.235.03	13.235.06	13.235.07	13.236	13.238	13.517
H x L (mm)	60	85	125	60	85	45	70	230 x 210
φ / □ (mm)	□ 25	□ 40	□ 60	φ 27	φ 42	φ 30	φ 55	φ 60
W (kg)	0,180	0,540	1,680	0,160	0,550	0,140	0,800	5,600

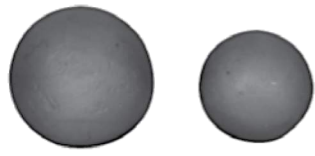

ШАРЫ ПОЛНОТЕЛЫЕ ГЛАДКИЕ

NR ART	φ (mm)	W (kg)
13.240	15	0,017
13.241	20	0,032
13.242	25	0,064
13.243	30	0,116
13.244	35	0,186
13.245	40	0,260
13.246	50	0,510

ШАРЫ ПУСТОТЕЛЫЕ ЗАМКНУТЫЕ

NR ART	φ (mm)	G (mm)	W (kg)
13.249.30	30	1,5	0,022
13.249.40	40	1,5	0,068
13.249.50	50	1,5	0,086
13.249.60	60	1,5	0,135
13.249.70	70	1,5	0,175
13.249.80	80	1,5	0,237
13.249.90	90	1,5	0,301
13.249.100	100	1,5	0,368
13.249.120	120	1,5	0,674
13.249.150	150	1,5	1,420
13.249.200	200	1,5	1,818

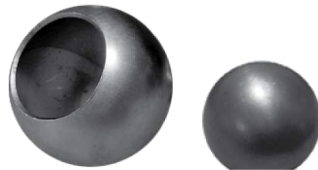
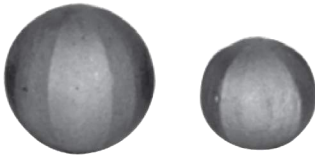

ШАРЫ ПОЛНОТЕЛЫЕ НЕ ГЛАДКИЕ

NR ART	φ (mm)	W (kg)
13.258	20	0,032
13.259	25	0,064
13.260	30	0,111
13.261	35	0,180
13.262	40	0,300
13.263	50	0,520
13.264	60	0,860

ШАРЫ ПУСТОТЕЛЫЕ С ОТВЕРСТИЕМ

NR ART	φ (mm)	Otw.	G (mm)	W (kg)
13.251.15	15	□ 7,3	1,5	0,004
13.251.20	20	□ 9,5	1,5	0,009
13.251.25	25	□ 11	1,5	0,019
13.251.30	30	□ 13	1,5	0,032
13.251.35	35	□ 19	1,5	0,041
13.251.40	40	φ 20,6	1,5	0,062
13.251.50	50	φ 29,7	1,5	0,090
13.251.60	60	φ 30,3	1,5	0,125
13.251.70	70	φ 36,4	1,5	0,175
13.251.80	80	φ 42,0	1,5	0,245
13.251.90	90	φ 44,7	1,5	0,350
13.251.100	100	φ 54,3	1,5	0,400
13.251.120	120	φ 63,3	1,5	0,725
13.251.150	150	φ 78,3	1,5	1,100



ШАРЫ ПОЛНОТЕЛЫЕ С РЁБРАМИ

NR ART	φ (mm)	W (kg)
13.450.22	22	0,030
13.450.32	32	0,115
13.450.40	40	0,250
13.450.50	50	0,500

ШАРЫ ПУСТОТЕЛЫЕ С ОТВЕРСТИЕМ РЕЗЬБОВЫМ

NR ART	φ (mm)	M (mm)	G (mm)	W (kg)
13.270.30	30	M6	1,5	0,049
13.270.40	40	M8	1,5	0,068
13.270.50	50	M8	1,5	0,100
13.270.60	60	M10	1,5	0,149
13.270.70	70	M10	1,5	0,184
13.270.80	80	M12	1,5	0,243
13.270.90	90	M12	1,5	0,389
13.270.100	100	M12	1,5	0,403
13.270.120	120	M12	1,5	0,661
13.270.150	150	M12	1,5	1,402

ПОЛУСФЕРЫ

NR ART	φ (mm)	G (mm)	W (kg)
13.280.40	40	1,5	0,026
13.280.50	50	1,5	0,045
13.280.60	60	1,5	0,068
13.280.70	70	1,5	0,089
13.280.80	80	1,5	0,126
13.280.90	90	1,5	0,154
13.280.100	100	1,5	0,199
13.280.120	120	1,5	0,331
13.280.150	150	1,5	0,502
13.280.200	200	1,5	0,908





NR ART	13.303	13.305	13.306	13.310.01	13.310.02	13.310.03	13.310.05
H x L (mm)	90 x 90	70 x 70	50 x 50	120 x 50	148 x 60	200 x 85	250 x 130
□ (mm)	□ 26	□ 21	□ 12				
G (mm)	8	8	6	4	4	4	4
W (kg)	0,450	0,278	0,105	0,100	0,140	0,310	0,580

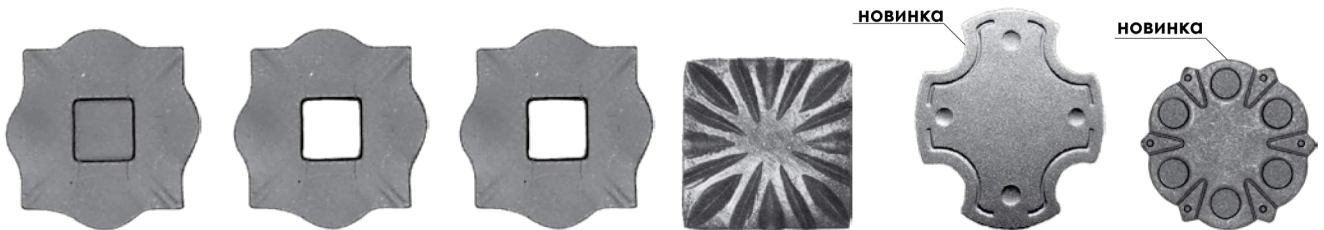

NR ART	13.311	13.312	13.313	13.314.19	13.426	13.428
H x L (mm)	100 x 100	100 x 100	100 x 100	85 x 85	140 x 120	∅ 105
□ (mm)	БЕЗ ОТВ.	□ 25	□ 30	БЕЗ ОТВ.	БЕЗ ОТВ.	БЕЗ ОТВ.
G (mm)	10	10	10	10	3	5
W (kg)	0,465	0,380	0,360	0,390	0,260	0,280



NR ART	13.432	13.432.01	13.432.02	13.433.01	13.433.02	13.434
H x L (mm)	100 x 100	80 x 80	120 x 120	80 x 80	120 x 120	120 x 120
G (mm)	7	7	7	7	7	7
W (kg)	0,600	0,400	0,800	0,400	0,800	0,800



NR ART	13.434.01	13.434.02	13.437	13.440	13.547	13.550	13.553
H x L (mm)	100 x 100	80 x 80	100 x 100	60 x 60	154	160 x 105	135 x 35
G (mm)	8	8	8	8		6	
W (kg)	0,600	0,400	0,600	0,150	0,180	0,450	0,210

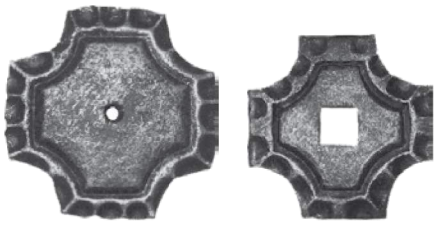

NR ART	H x L (mm)	□ (mm)	W (kg)
13.313.11	65 x 65	bez otw.	0,100
13.313.12	75 x 75	bez otw.	0,150
13.315.12	65 x 65	□ 12	0,100
13.316.16	75 x 75	□ 16	0,160
13.316.20	75 x 75	□ 20	0,150
13.316.25	75 x 75	□ 25	0,140

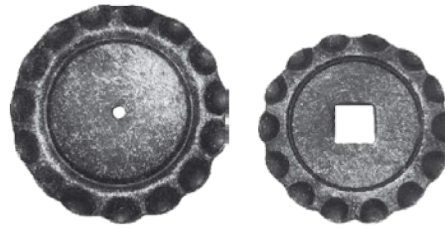

NR ART	∅ (mm)	□ (mm)	W (kg)
13.313.13	∅ 65	БЕЗ ОТВ	0,110
13.313.14	∅ 75	БЕЗ ОТВ	0,160
13.317.12	∅ 65	□ 12	0,100
13.318.16	∅ 75	□ 16	0,140
13.318.20	∅ 75	□ 20	0,130
13.318.25	∅ 75	□ 25	0,120

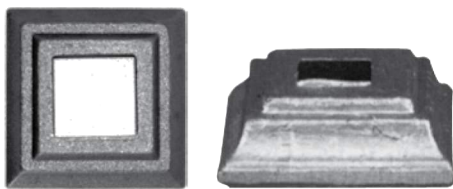

NR ART	H x L (mm)	□ (mm)	W (kg)
13.319	80 x 80	□ 30,5	0,280
13.321	80 x 80	□ 40,5	0,280
13.322	60 x 60	□ 25,5	0,180
13.323	60 x 60	□ 30,5	0,180
13.326	50 x 50	□ 20,5	0,110
13.327	40 x 40	□ 12,5	0,070
13.328	40 x 40	□ 14,5	0,070
13.329	40 x 40	□ 16,5	0,070



NR ART	H (mm)	∅ (mm)	W (kg)
13.333	20	∅ 80	0,230
13.334	20	∅ 60	0,140
13.336	20	∅ 40	0,050



NR ART	H x L (mm)	□ (mm)	W (kg)
13.435	75 x 75	БЕЗ ОТВ	0,200
13.435.20	75 x 75	□ 20	0,190
13.435.25	75 x 75	□ 25	0,180
13.435.30	75 x 75	□ 30	0,170
13.435.40	75 x 75	□ 40	0,160
13.435.41	75 x 75	□ 40 x 10	0,180
13.435.42	75 x 75	□ 40 x 20	0,180
13.436	50 x 50	БЕЗ ОТВ	0,110
13.436.12	50 x 50	□ 12	0,100
13.436.14	50 x 50	□ 14	0,090
13.436.16	50 x 50	□ 16	0,080
13.436.20	50 x 50	□ 20	0,070



NR ART	∅ (mm)	□ (mm)	W (kg)
13.439.01	∅ 64	БЕЗ ОТВ	0,060
13.439.12	∅ 64	□ 12	0,056
13.439.14	∅ 64	□ 14	0,055
13.439.16	∅ 64	□ 16	0,054
13.439.20	∅ 64	□ 20	0,050
13.439.25	∅ 64	□ 25	0,050
13.439.30	∅ 64	□ 30	0,048
13.439.40	∅ 64	□ 40	0,046
13.439.41	∅ 64	□ 40 x 10	0,050
13.439.42	∅ 64	□ 40 x 20	0,048



NR ART	H (mm)	□ (mm)	G (mm)	W (kg)
13.440.01	100 x 100	БЕЗ ОТВ	2,5	0,200
13.440.02	78 x 78	БЕЗ ОТВ	2,5	0,120
13.441.12	78 x 78	□ 12	2,5	0,120
13.441.14	78 x 78	□ 14	2,5	0,120
13.441.16	78 x 78	□ 16	2,5	0,120
13.441.20	100 x 100	□ 20	2,5	0,180
13.441.25	100 x 100	□ 25	2,5	0,170
13.441.30	100 x 100	□ 30	2,5	0,160
13.441.40	100 x 100	□ 40	2,5	0,150



NR ART	∅ (mm)	∅ ОТВ. (mm)	G (mm)	H (mm)
13.483	∅ 98/55	БЕЗ ОТВ	1,0	30,0
13.483.25	∅ 98/55	∅ 25	1,0	30,0
13.483.32	∅ 98/55	∅ 32	1,0	30,0
13.483.42	∅ 98/55	∅ 42	1,0	30,0
13.483.52	∅ 98/55	∅ 52	1,0	30,0



NR ART	□ (mm)	□ ОТВ. (mm)	G (mm)	H (mm)
13.484	44 x 44	БЕЗ ОТВ	1,0	20,0
13.484.10	44 x 44	□ 10	1,0	20,0
13.484.12	44 x 44	□ 12	1,0	20,0
13.484.14	44 x 44	□ 14	1,0	20,0
13.486	60 x 60	БЕЗ ОТВ	1,0	20,0
13.486.16	60 x 60	□ 16	1,0	20,0
13.486.20	60 x 60	□ 20	1,0	20,0
13.488	80 x 80	БЕЗ ОТВ	1,0	30,0
13.488.25	80 x 80	□ 25	1,0	30,0
13.488.30	80 x 80	□ 30	1,0	30,0
13.488.32	80 x 80	▮ 30 x 20	1,0	30,0
13.488.42	80 x 80	▮ 40 x 20	1,0	30,0
13.489.30	92 x 92	□ 30	1,0	30,0
13.489.40	92 x 92	□ 40	1,0	30,0
13.489.53	92 x 72	▮ 50 x 30	1,0	30,0
13.490	108 x 108	БЕЗ ОТВ	1,0	30,0
13.490.50	108 x 108	□ 50	1,0	30,0
13.490.60	108 x 108	□ 62	1,0	30,0
13.491.64	112 x 92	▮ 60 x 40	1,0	30,0
13.492	122 x 122	БЕЗ ОТВ	1,0	30,0
13.492.60	122 x 122	□ 60	1,0	30,0
13.492.80	122 x 122	□ 80	1,0	30,0



NR ART	14.001	14.003	14.004	14.005.06	14.005.07	14.014	14.015
φ (mm)	φ 95	φ 95	φ 62	φ 60	φ 90	φ 60	φ 95
G (mm)	5	5	4	2	2	3	3
W (kg)	0,320	0,250	0,145	0,005	0,100	0,080	0,160

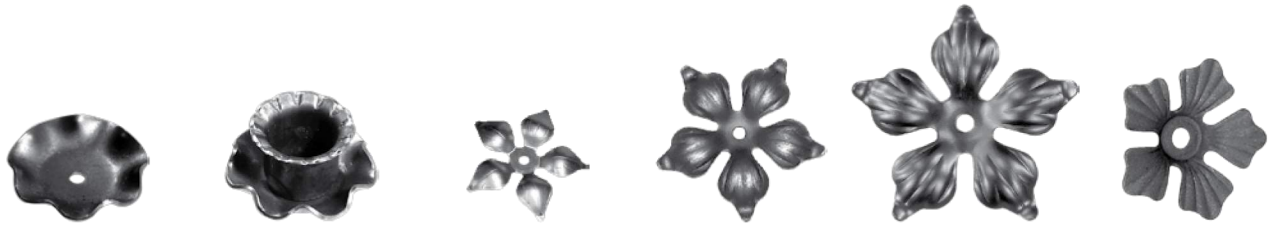

NR ART	14.017	14.017.01	14.020	14.021	14.021.01	14.022
H (mm)		20				
φ (mm)	φ 50	φ 50	φ 70	φ 90	φ 135	φ 86
G (mm)	1	1	1	2	2	2
W (kg)	0,240	0,044	0,020	0,060	0,160	0,060

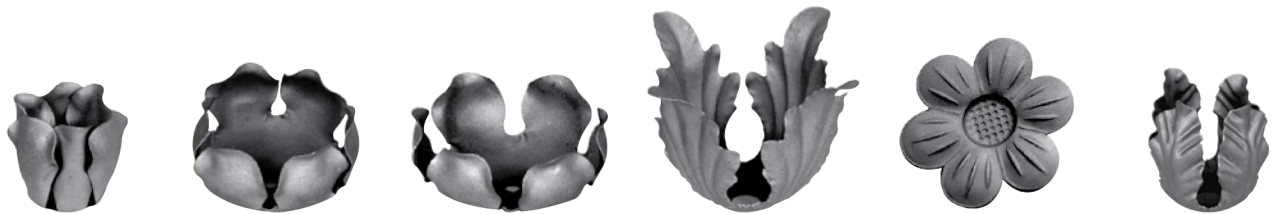

NR ART	14.024	14.025	14.026	14.027	14.027.01	14.030
H (mm)	40	35	30	70		42
φ (mm)	φ 40	φ 55	φ 65	φ 90	φ 60	φ 40
G (mm)	0,5	0,5	0,5	0,6	2	0,6
W (kg)	0,018	0,019	0,210	0,035	0,036	0,016

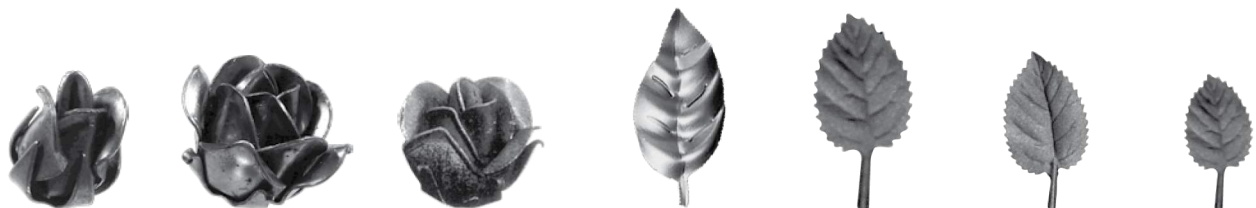

NR ART	14.035.02	14.035.03	14.035.12	14.036	14.037	14.038	14.038.01
H x L (mm)	43	48	45	80 x 35	85 x 45	70 x 35	60 x 28
φ (mm)	φ 35	φ 60	φ 45				
G (mm)	1,5	1,5	1,5	1	0,5	0,5	0,5
W (kg)	0,053	0,120	0,080	0,020	0,010	0,006	0,004

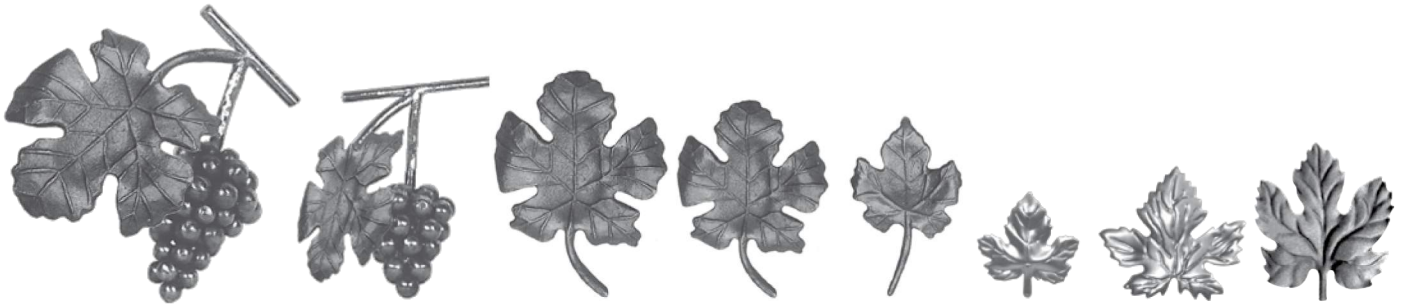

NR ART	14.039.04	14.039.05	14.039.10	14.039.11	14.039.14	14.040	14.041	14.042
H x L (mm)	200 x 140	150 x 100	155 x 110	135 x 85	125 x 75	57 x 55	75 x 70	105 x 95
G (mm)						0,6	0,6	0,6
W (kg)	1,220	0,720	0,320	0,200	0,138	0,006	0,010	0,039



NR ART	14.059	14.060	14.061	14.062	14.063	14.064	14.069	14.070	14.073	14.074
H x L (mm)	155 x 60	155 x 60	110 x 40	110 x 40	90 x 30	90 x 30	80 x 60	80 x 60	55 x 70	55 x 70
W (kg)	0,110	0,110	0,065	0,065	0,036	0,036	0,060	0,060	0,046	0,046



NR ART	14.077	14.078	14.078.02	14.078.04	14.081	14.083.02	14.083.03	14.083.06	14.083.07
H x L (mm)	110 x 75	110 x 75	185 x 100	210 x 50	165 x 75	∅ 90	∅ 55	∅ 90	∅ 50
W (kg)	0,089	0,089	0,320	0,240	0,200	0,240	0,081	0,430	0,100



NR ART	14.084.01	14.084.02	14.084.03	14.084.04	14.084.05	14.084.06	14.085.01	14.085	14.086
H x L (mm)	80 x 70	∅ 100	135 x 85	115 x 100	135 x 85	115 x 100	150 x 40	330 x 260	190 x 125
G (mm)	3	3	3	3	3	3			
W (kg)	0,084	0,116	0,100	0,110	0,100	0,110	0,130	1,300	0,400



NR ART	14.087	14.087.06	14.087.08	14.087.13	14.087.14	14.087.15	14.087.16
H x L (mm)	130 x 75	90 x 55	225 x 60	140 x 110	140 x 110	190 x 160	190 x 160
G (mm)		4	4				
W (kg)	0,110	0,100	0,200	0,180	0,180	0,400	0,400

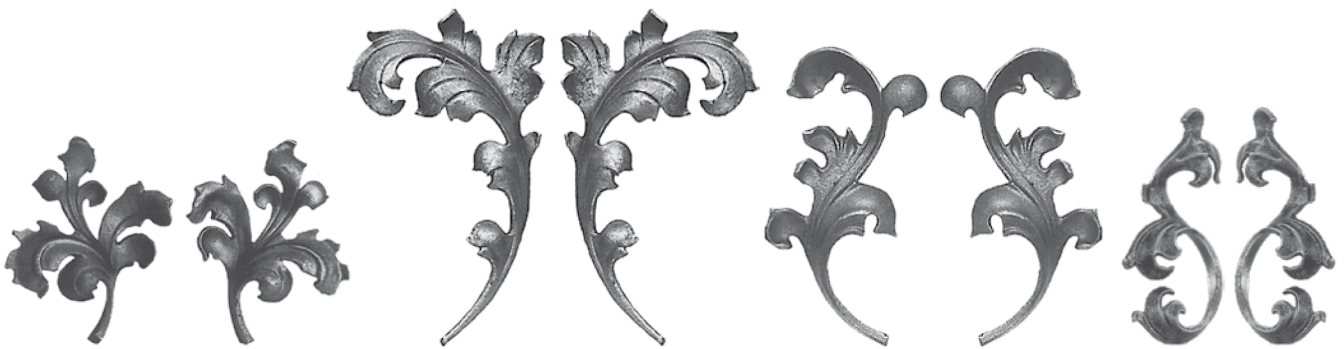

NR ART	14.087.17	14.087.18	14.087.19	14.087.20	14.087.21	14.087.22	14.087.23	14.087.24
H x L (mm)	155 x 140	155 x 140	250 x 150	250 x 150	220 x 105	220 x 105	180 x 85	180 x 85
W (kg)	0,280	0,280	0,460	0,460	0,290	0,290	0,230	0,230



NR ART	14.087.25	14.087.26	14.087.27	14.087.28	14.087.29	14.087.30
H x L (mm)	180 x 115	180 x 115	234 x 104	230 x 130	230 x 130	160 x 160
W (kg)	0,250	0,250	0,320	0,320	0,320	0,330



NR ART	14.087.31	14.087.32	14.241.13	14.241.14	14.242.01	14.242.02	14.242.07	14.242.08
H x L (mm)	∅ 90 x 60	∅ 90	125 x 52	125 x 52	80 x 45	80 x 45	225 x 130	225 x 130
W (kg)	0,180	0,120	0,100	0,100	0,040	0,040	0,650	0,650



NR ART	14.243.14	14.243.17	14.243.18	14.243.20	14.245.10	14.245.12
H x L (mm)	95 x 80	∅ 70	∅ 90	75 x 90	∅ 90	∅ 120
W (kg)	0,120	0,110	0,300	0,280	0,170	0,480



NR ART	14.248.05	14.291.05	14.292.12	14.292.13	14.292.14	14.292.15
H x L (mm)	410 x 70	135 x 110	115 x 105	115 x 105	175 x 110	175 x 110
∅ (mm)	∅ 6	∅ 14				
W (kg)	2,200	0,340	0,170	0,170	0,320	0,320



NR ART	14.301.01	14.301.02	14.301.03	14.301.04	14.301.05	14.301.06	14.301.07	14.301.08
H x L (mm)	450 x 160	240 x 140	70 x 50	50 x 40	200 x 205	130 x 130	550 x 370	210 x 105
G (mm)			2	2	2	2		
W (kg)	0,540	0,220	0,040	0,020	0,140	0,080	5,260	0,140



NR ART	14.301.11	14.301.12	14.301.13	14.301.14	14.301.21	14.301.22	14.301.28
H x L (mm)	75 x 50	75 x 50	55 x 40	55 x 40	70 x 60	40 x 45	40 x 30
W (kg)	0,045	0,045	0,020	0,020	0,320	0,140	0,060



NR ART	14.301.61	14.301.62	14.301.71	14.301.72	14.301.77	14.301.78
H x L (mm)	130 x 55	130 x 55	130 x 135	130 x 135	155 x 95	155 x 95
G (mm)	2	2	1,5	1,5	1,5	1,5
W (kg)	0,060	0,060	0,160	0,160	0,120	0,120



NR ART	14.302.01	14.302.02	14.302.03	14.302.04	14.302.05	14.302.06	14.302.07
H x L (mm)	110	80	65	150 x 140	125 x 115	95 x 90	75 x 70
W (kg)	1,340	0,740	0,360	0,260	0,140	0,080	0,040



NR ART	14.302.08	14.302.09	14.302.10	14.302.11	14.302.13
H x L (mm)	450 x 380	450 x 380	250 x 300	250 x 300	70
W (kg)	5,240	5,240	1,880	1,880	0,050



NR ART	14.302.54	14.302.55	14.302.56	14.303.01	14.303.02	14.303.03
H x L (mm)	205 x 195	175 x 166	150 x 142	∅ 120	∅ 90	∅ 65
G (mm)	2	2	2	3	3	3
W (kg)	0,300	0,200	0,150	0,180	0,120	0,060



NR ART	14.303.04	14.303.05	14.303.06	14.303.07	14.303.08	14.303.09	14.303.10
H x L (mm)	115 x 115	70 x 70	45 x 45	80 x 80	60 x 60	∅ 115	∅ 115
G (mm)	1,5	1,5	1,5	1,5	1,5	4	4
W (kg)	0,060	0,040	0,020	0,028	0,016	0,320	0,320

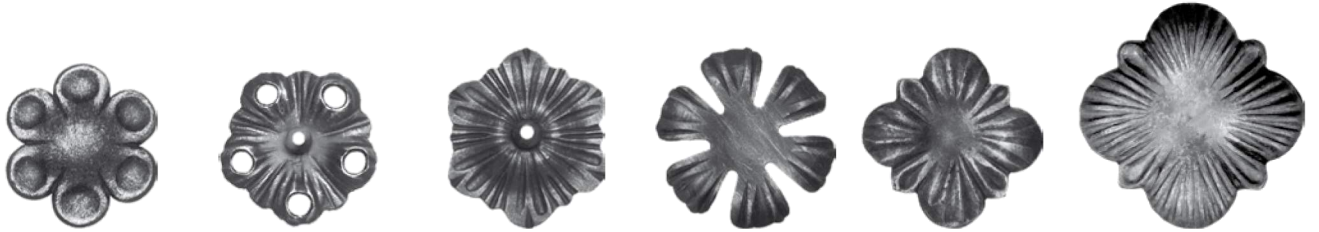

NR ART	14.303.14	14.303.15	14.303.16	14.303.17	14.303.18	14.303.20
H x L (mm)	∅ 95	∅ 100	120	110	120	150
G (mm)	5	4	4	5	5	5
W (kg)	0,260	0,180	0,270	0,210	0,340	0,550



NR ART	14.303.21	14.303.22	14.303.23	14.303.24	14.303.29	14.303.30
H x L (mm)	410 x 165	275 x 105	250 x 45	160 x 110	300 x 260	300 x 260
G (mm)			2	2	2,5	2,5
W (kg)	0,640	0,170	0,100	0,110	0,450	0,450



NR ART	14.303.31	14.303.32	14.303.33	14.303.34	14.303.35	14.303.36
H x L (mm)	190 x 170	190 x 170	200 x 210	200 x 210	270 x 100	270 x 100
G (mm)	2,5	2,5	2,5	2,5	2,5	2,5
W (kg)	0,350	0,350	0,300	0,300	0,250	0,250



NR ART	14.304.01	14.304.02	14.304.03	14.304.04	14.304.05	14.304.06
H x L (mm)	55 x 90	55 x 90	85 x 85	85 x 85	70 x 110	70 x 110
G (mm)	4	4	4	4	4	4
W (kg)	0,100	0,100	0,140	0,140	0,150	0,150



NR ART	14.304.07	14.304.08	14.304.11	14.304.12	14.304.13	14.304.14
H x L (mm)	140 x 105	140 x 105	110 x 85	110 x 85	90 x 100	90 x 100
G (mm)	4	4	3	3	3	3
W (kg)	0,310	0,310	0,120	0,120	0,130	0,130



NR ART	14.304.15	14.304.16	14.304.17	14.304.18	14.304.19	14.304.20
H x L (mm)	60 x 80	60 x 80	80 x 150	165 x 60	105 x 95	105 x 95
G (mm)	3	3	1,5	3	3	3
W (kg)	0,060	0,060	0,200	0,300	0,100	0,100



NR ART	14.304.21	14.304.22	14.304.23	14.304.24	14.304.25	14.304.26	14.304.31	14.304.32
H x L (mm)	85 x 125	85 x 125	125 x 85	125 x 85	150 x 135	150 x 135	130 x 70	130 x 70
G (mm)	3	3	3	3	4	4	4	4
W (kg)	0,200	0,200	0,100	0,100	0,260	0,260	0,160	0,160



NR ART	14.304.33	14.304.34	14.304.41	14.304.42	14.304.43	14.304.44
H x L (mm)	160 x 205	160 x 250	235 x 230	210 x 180	140 x 110	85 x 45
G (mm)	4	4	2,5	2,5	2,5	5
W (kg)	0,580	0,580	0,540	0,380	0,130	0,060



NR ART	14.305.01	14.305.02	14.305.11	14.305.12	14.305.13	14.305.14	14.305.15	14.305.16
H x L (mm)	115 x 125	115 x 125	85 x 50	155 x 90	240 x 65	225 x 115	85 x 75	75 x 175
G (mm)	4	4	3	4	4	4	2,5	2,5
W (kg)	0,210	0,210	0,050	0,190	0,250	0,340	0,170	0,170



NR ART	14.305.18	14.305.20	14.305.21	14.305.22	14.305.34	14.305.35
H x L (mm)	240 x 60	220 x 45	115 x 200	90 x 145	225 x 195	225 x 195
G (mm)	4	4	2	2	1,5	1,5
W (kg)	0,190	0,120	0,260	0,140	0,320	0,320



NR ART	14.305.36	14.305.37	14.305.41	14.305.42	14.305.43	14.305.44	14.305.45
H x L (mm)	270 x 250	270 x 250	260 x 75	240 x 85	240 x 85	255 x 70	235 x 85
G (mm)			2	2	2	2	2
W (kg)	1,340	1,340	0,280	0,250	0,250	0,260	0,240



NR ART	14.306.01	14.306.02	14.306.03	14.306.04
H x L (mm)	∅ 115 x 35	195 x 130	155 x 105	115 x 75
G (mm)		2	2	2
W (kg)	0,320	0,260	0,150	0,080

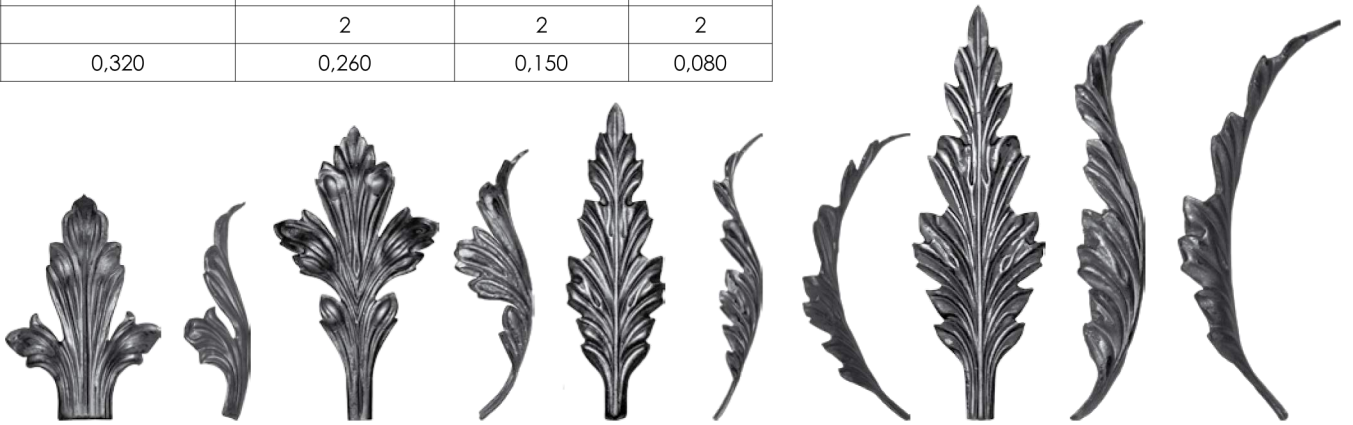

NR ART	14.306.11	14.306.13	14.306.16	14.306.17	14.306.21	14.306.22	14.306.23	14.306.25	14.306.26	14.306.27
H x L (mm)	200 x 140	190 x 70	260 x 150	240 x 70	280 x 85	250 x 50	250 x 50	370 x 120	350 x 60	350 x 60
G (mm)	2,5	2,5	2,5	2,5	2,5	2,5	2,5	2,5	2,5	2,5
W (kg)	0,200	0,200	0,350	0,350	0,350	0,350	0,350	0,450	0,450	0,450



NR ART	14.306.31	14.306.35	14.306.41	14.306.42	14.306.51
H x L (mm)	205 x 220	55 x 55	∅ 90	∅ 150	140 x 140
G (mm)	2	4	1	2	2
W (kg)	0,250	0,050	0,060	0,250	0,200



NR ART	14.306.64	14.306.65	14.306.66	14.306.71	14.306.72	14.306.73	14.306.78
H x L (mm)	140 x 120	120 x 85	90 x 65	∅ 130 x 160	∅ 90 x 160	∅ 75 x 160	50 x 140
G (mm)	2,0	2,0	2,0	1,0	1,0	1,0	1,0
W (kg)	0,180	0,110	0,060	0,380	0,280	0,280	0,100



NR ART	14.307.01	14.307.02	14.307.03	14.307.04	14.307.05	14.307.06	14.307.07	14.307.08	14.307.09	14.307.54
H x L (mm)	170 x 95	140 x 75	100 x 55	35	28	85	65	60	117 x 52	65 x 45
W (kg)	0,160	0,100	0,040	0,080	0,040	0,200	0,160	0,120	0,080	0,060



NR ART	14.308.01	14.308.02	14.308.03	14.308.07	14.308.08	14.308.09	14.308.10	14.308.11	14.308.12
H x L (mm)	130 x 45	115 x 45	95 x 30	340 x 210	340 x 210	330 x 150	330 x 150	330 x 165	330 x 165
G (mm)	3	3	3						
W (kg)	0,080	0,060	0,040	0,800	0,800	0,480	0,480	0,380	0,380



NR ART	14.309.01	14.309.02	14.309.03	14.309.04	14.309.05	14.309.06	14.309.08	14.309.09
H x L (mm)	225 x 60	210 x 135	210 x 135	210 x 75	200 x 110	200 x 110	500	305
G (mm)	5	5	5	15	15	15	2	2
W (kg)	0,300	0,280	0,280	0,400	0,440	0,440	0,250	0,250



NR ART	14.310.01	14.310.02	14.310.03	14.310.04	14.310.05
H x L (mm)	∅ 115 x 55	∅ 90 x 40	145 x 90	115 x 70	85 x 50
G (mm)			4	4	4
W (kg)	0,560	0,360	0,280	0,170	0,100



NR ART	14.311.01	14.311.02	14.311.03	14.311.04	14.311.05
H x L (mm)	170 x 160	170 x 145	105 x 65	105 x 65	50 x 40
G (mm)	2	2	2	2	
W (kg)	0,220	0,210	0,065	0,065	0,130



NR ART	14.312.01	14.312.02	14.312.03	14.312.05	14.312.11	14.312.12	14.312.51
H x L (mm)	90 x 70	80 x 60	70 x 55	500 x 100	200 x 240	200 x 240	155 x 145
G (mm)					1,5	1,5	1
W (kg)	0,280	0,250	0,230		0,350	0,350	0,160

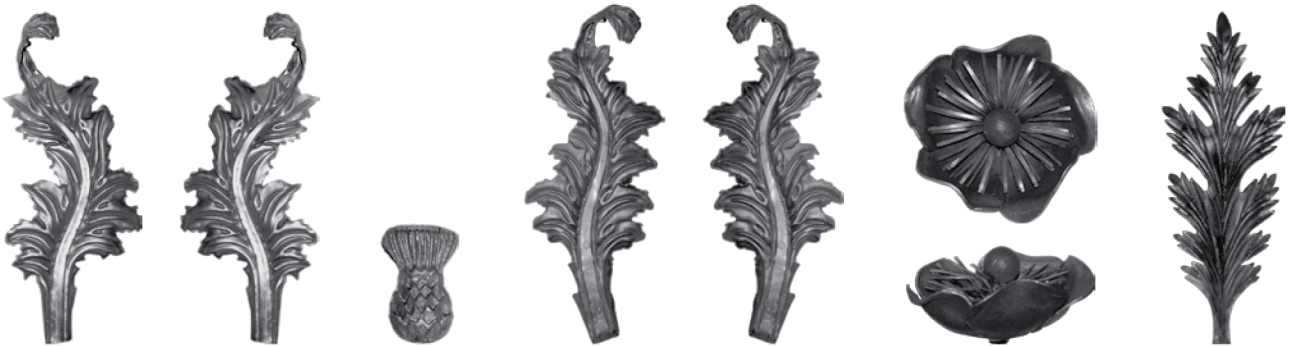

NR ART	14.313.01	14.313.02	14.313.03	14.313.11	14.313.12	14.313.51	14.313.52
H x L (mm)	335 x 145	335 x 145	80 x 55	345 x 140	345 x 140	60 x 130	330 x 130
G (mm)	2	2	1,5	2	2	2	2
W (kg)	0,340	0,340	0,060	0,340	0,340	0,420	0,350



NR ART	14.314.01	14.314.02	14.314.03	14.314.04	14.314.05	14.314.06	14.314.07	14.314.08
H x L (mm)	230 x 240	210 x 210	185 x 175	160 x 150	∅ 40	∅ 40	70 x 60	140 x 110
G (mm)	3	3	3	3				
W (kg)	0,860	0,650	0,540	0,400	0,100	0,140	0,060	0,160



NR ART	14.315.01	14.315.10	14.315.02	14.315.11	14.315.03	14.315.12	14.315.04	14.315.05	14.315.06
H x L (mm)	115 x 190	85 x 140	125 x 140	90 x 100	130 x 50	100 x 40	115 x 45	85 x 40	65 x 30
G (mm)							3	3	3
W (kg)	0,760	0,480	0,660	0,480	0,300	0,260	0,110	0,080	0,050



NR ART	14.315.07	14.317.01	14.317.02	14.317.03	14.317.04	14.317.05
H x L (mm)	420	110 x 130	95 x 110	60 x 70	70	55
G (mm)		2,5	2,5	2,5		
W (kg)	2,120	0,160	0,100	0,040	0,240	0,140



NR ART	14.318.01	14.318.02	14.318.03	14.318.04	14.318.05	14.318.06	14.318.07
H x L (mm)	270 x 65	240 x 60	210 x 55	180 x 45	350 x 315	350 x 315	∅ 30 x 50
G (mm)	1,5	1,5	1,5	1,5	1,5	1,5	
W (kg)	0,150	0,100	0,080	0,060	0,710	0,710	0,100



NR ART	14.319.01	14.319.02	14.319.03	14.319.04	14.319.05	14.319.06	14.319.07
H x L (mm)	190 x 200	155 x 163	125 x 132	95 x 100	35 x 125	35 x 63	35 x 63
G (mm)	2	2	2	2	2	2	2
W (kg)	0,280	0,180	0,120	0,060	0,040	0,020	0,020



NR ART	14.441	14.442	14.450	14.451	14.466.01	14.466.02
H x L (mm)	∅ 105	∅ 74	∅ 85	∅ 60	92	119
G (mm)	5	6	2,5	2,5		
W (kg)	0,330	0,23	0,150	0,080	0,100	0,160



NR ART	14.501.01	14.501.02	14.502.01	14.502.02	14.503.01	14.503.02	14.506
H x L (mm)	160 x 85	160 x 85	190 x 75	190 x 75	90 x 60	90 x 60	100 x 72
G (mm)	2	2	1,5	1,5	4	4	2
W (kg)	0,120	0,120	0,100	0,100	0,070	0,070	0,080



NR ART	14.510.01	14.510.02	14.511.01	14.511.02	14.550	14.552	14.556
H x L (mm)	125 x 50	125 x 50	107 x 62	107 x 62	∅ 50	∅ 52	∅ 135
G (mm)	2,5	2,5	2,5	2,5		2,5	
W (kg)	0,050	0,050	0,040	0,040	0,040	0,050	0,170

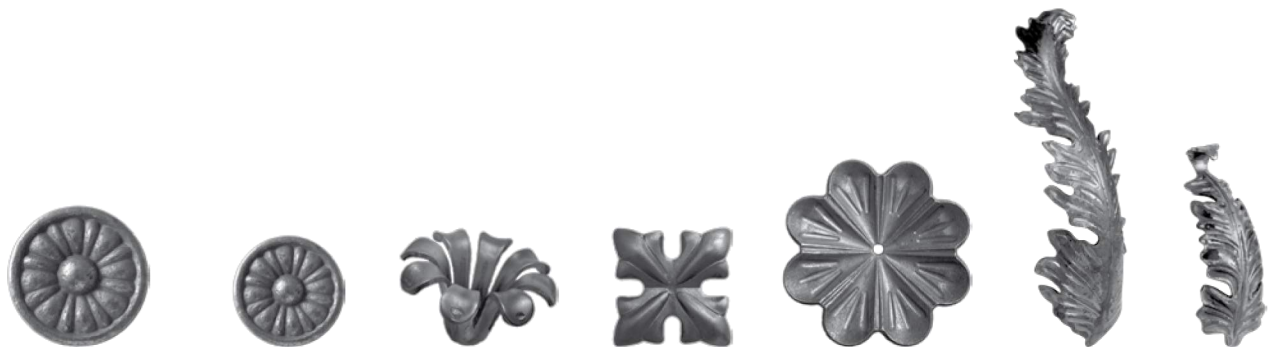

NR ART	14.563.01	14.563.02	14.565	14.566	14.567	14.692.08	14.692.09
H x L (mm)	∅ 64	∅ 46	∅ 52 x 33	44 x 44	∅ 122	330 x 100	180 x 50
G (mm)	6	5	2,5	2,5	4	4	4
W (kg)	0,200	0,160	0,040	0,250	0,320	0,975	0,290



NR ART	14.704.02	14.704.03	14.704.04	14.705.01	14.705.02	14.705.03	14.705.04
H x L (mm)	115 x 155	225 x 305	225	300 x 120	300 x 120	90 x 85	90 x 85
G (mm)	1,5	1,5	1,5	2	2	2	2
W (kg)	0,160	0,040	0,250	0,200	0,200	0,080	0,080



NR ART	14.708.01	14.708.02	14.709.01	14.710.01	14.710.02	14.711.01	14.711.02
H x L (mm)	160 x 180	160 x 180	145 x 145	260 x 180	165 x 165	200 x 100	245 x 145
G (mm)	5	5	1,5	2	2	2	2
W (kg)	0,760	0,760	0,260	0,300	0,160	0,220	0,470

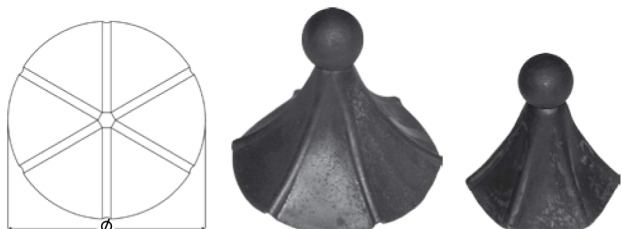

NR ART	∅ (mm)	H (mm)	G (mm)	W (kg)
15.010	∅ 100	120	3	0,660
15.013	∅ 130	145	3	0,840
15.015	∅ 155	145	3	1,260
15.018	∅ 180	150	3	1,460

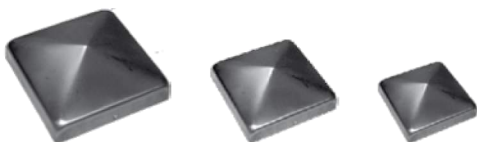

NR ART	□ (mm)	H (mm)	W (kg)
15.020	□ 20 x 20	20	0,020
15.025	□ 25 x 25	20	0,025
15.030	□ 30 x 30	20	0,030
15.040	□ 40 x 40	20	0,040
15.050	□ 50 x 50	20	0,043
15.060	□ 60 x 60	20	0,061
15.070	□ 70 x 70	20	0,076
15.080	□ 80 x 80	20	0,096
15.090	□ 90 x 90	20	0,104
15.100	□ 100 x 100	20	0,110
15.120	□ 120 x 120	20	0,134

NR ART	□ (mm)	H (mm)	W (kg)
15.053	□ 40 x 40	5	0,045
15.054	□ 50 x 50	5	0,065
15.055	□ 60 x 60	5	0,080
15.056	□ 80 x 80	5	0,135
15.057	□ 100 x 100	5	0,195
15.058	□ 120 x 120	5	0,260



NR ART	□ (mm)	∅ ШАП (mm)	W (kg)
15.040.40	□ 40 x 40	∅ 40	0,083
15.040.60	□ 40 x 40	∅ 60	0,152
15.050.40	□ 50 x 50	∅ 40	0,101
15.050.50	□ 50 x 50	∅ 50	0,120
15.060.50	□ 60 x 60	∅ 50	0,120
15.060.60	□ 60 x 60	∅ 60	0,175
15.060.80	□ 60 x 60	∅ 80	0,280
15.070.60	□ 70 x 70	∅ 60	0,195
15.070.70	□ 70 x 70	∅ 70	0,210
15.080.60	□ 80 x 80	∅ 60	0,220
15.080.70	□ 80 x 80	∅ 70	0,255
15.080.80	□ 80 x 80	∅ 80	0,320
15.080.100	□ 80 x 80	∅ 100	0,445
15.090.80	□ 90 x 90	∅ 80	0,335
15.090.90	□ 90 x 90	∅ 90	0,395
15.100.60	□ 100 x 100	∅ 60	0,245
15.100.80	□ 100 x 100	∅ 80	0,360
15.100.100	□ 100 x 100	∅ 100	0,465
15.120.80	□ 120 x 120	∅ 80	0,415
15.120.100	□ 120 x 120	∅ 100	0,520
15.120.120	□ 120 x 120	∅ 120	0,855

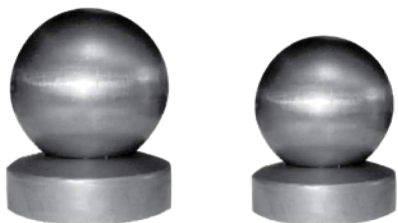

NR ART	∅ (mm)	∅ ШАП (mm)	W (kg)
15.142.40	∅ 42 (1 1/4")	∅ 40	0,123
15.142.50	∅ 42 (1 1/4")	∅ 50	0,130
15.148.50	∅ 48 (1 1/2")	∅ 50	0,145
15.148.60	∅ 48 (1 1/2")	∅ 60	0,152
15.160.60	∅ 60 (2")	∅ 60	0,185
15.160.80	∅ 60 (2")	∅ 80	0,185
15.172.70	∅ 72	∅ 70	0,285
15.172.80	∅ 72	∅ 80	0,303
15.177.60	∅ 77 (2 1/2")	∅ 60	0,300
15.177.80	∅ 77 (2 1/2")	∅ 80	0,320
15.180.60	∅ 80	∅ 60	0,235
15.180.80	∅ 80	∅ 80	0,245
15.190.90	∅ 90	∅ 90	0,389
15.200.80	∅ 100	∅ 80	0,365
15.200.100	∅ 100	∅ 100	0,410

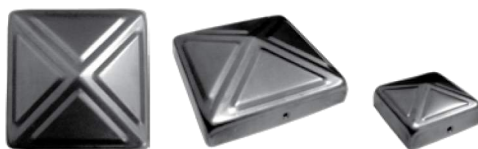

NR ART	□ (mm)	H (mm)	W (kg)
15.040.01	□ 40 x 40	20	0,040
15.050.01	□ 50 x 50	20	0,043
15.060.01	□ 60 x 60	20	0,061
15.070.01	□ 70 x 70	20	0,076
15.080.01	□ 80 x 80	20	0,096
15.090.01	□ 90 x 90	20	0,104
15.100.01	□ 100 x 100	20	0,110
15.120.01	□ 120 x 120	20	0,134



NR ART	□ (mm)	H (mm)	W (kg)
15.050.30	□ 50 x 30	20	0,035
15.060.40	□ 60 x 40	20	0,045
15.080.40	□ 80 x 40	20	0,051



NR ART	∅ (mm)	W (kg)
15.142	∅ 42 (1 1/4")	0,035
15.148	∅ 48 (1 1/2")	0,045
15.160	∅ 60 (2")	0,068
15.172	∅ 72	0,095
15.177	∅ 77 (2 1/2")	0,101
15.180	∅ 80	0,112
15.190	∅ 90	0,122
15.200	∅ 100	0,176
15.220	∅ 120	0,180



NR ART	∅ (mm)	G (mm)	H (mm)	W (kg)
15.291.41	∅ 41	1,5	10	0,018
15.291.50	∅ 50	1,5	12	0,025
15.291.60	∅ 60	1,5	12	0,040
15.291.68	∅ 68	1,5	14	0,050
15.291.90	∅ 90	1,5	14	0,125
15.291.108	∅ 108	1,5	14	0,140

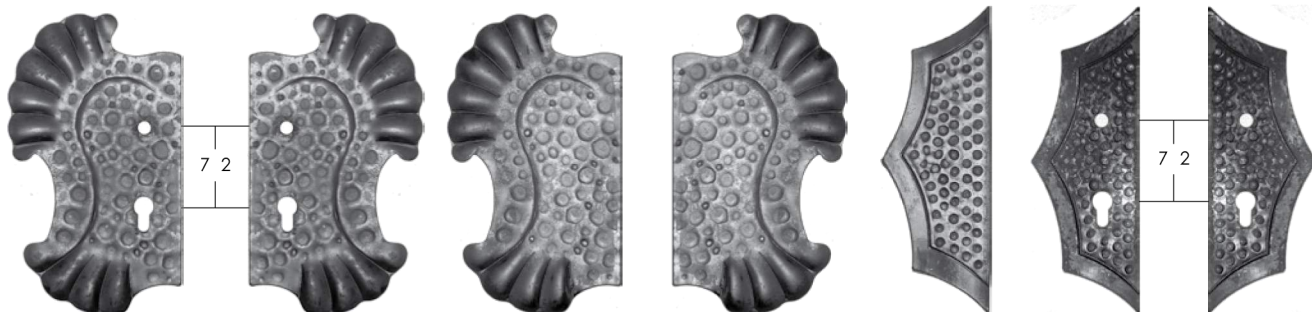

NR ART	15.042	15.043	15.042.01	15.043.01	15.271.01	15.271.03	15.271.04
H x L (mm)	270 x 160	270 x 160	270 x 160	270 x 160	275 x 95	275 x 95	275 x 95
G (mm)	3	3	3	3	5	5	5
W (kg)	0,800	0,800	0,800	0,800	0,540	0,540	0,540

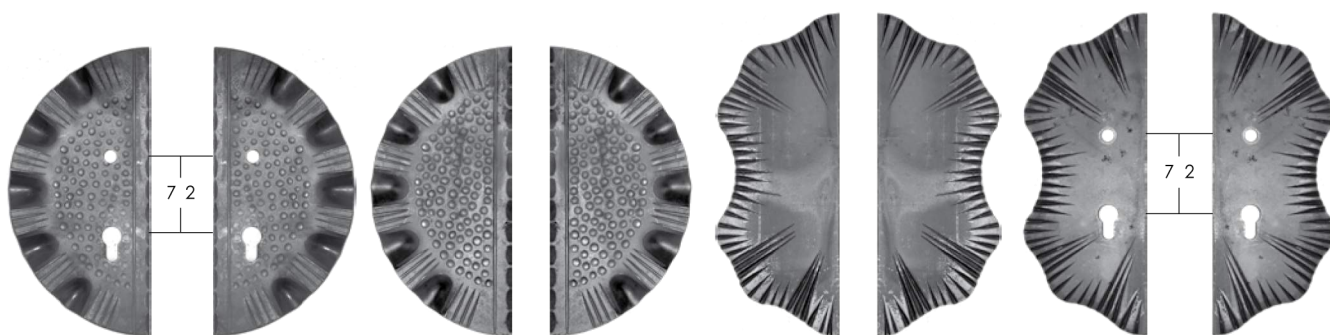

NR ART	15.272.01	15.272.02	15.272.05	15.272.06	15.273.41	15.273.42	15.273.51	15.273.52
H x L (mm)	263 x 128	263 x 128	263 x 128	263 x 128	285 x 105	285 x 105	285 x 105	285 x 105
G (mm)	3	3	3	3	5	5	5	5
W (kg)	0,570	0,570	0,570	0,570	0,800	0,800	0,800	0,800



NR ART	15.270.06	15.270.08	15.270.09	15.270.10	15.332	15.460.01	15.460.02
φ / H (mm)	φ 65	φ 65	φ 50	φ 50	50 x 23	φ 35	55 x 35
G (mm)	2	2	2	2		2,5	2,5
W (kg)	0,040	0,040	0,030	0,030	0,010	0,030	0,050



NR ART	15.361.01	15.361.02	15.361.03	15.361.04	15.361.05	15.361.06
H x L (mm)	330 x 180	330 x 180	330 x 180	330 x 180	330 x 180	330 x 180
G (mm)	4	4	4	4	4	4
W (kg)	1,360	1,360	1,360	1,360	1,360	1,360



NR ART	15.362.01	15.362.02	15.362.03	15.362.04	15.362.05	15.362.06	15.362.07	15.362.08
H x L (mm)	270 x 165	270 x 165	270 x 165	270 x 165	270 x 165	270 x 165	270 x 165	270 x 165
G (mm)	2,5	2,5	2,5	2,5	2,5	2,5	2,5	2,5
W (kg)	0,600	0,600	0,600	0,600	0,600	0,600	0,600	0,600

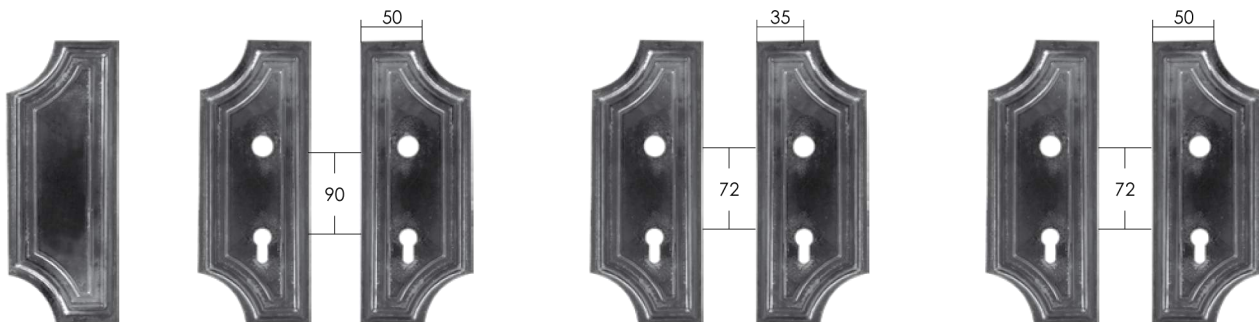

NR ART	15.363	15.363.01	15.363.02	15.363.03	15.363.04	15.363.05	15.363.06
H x L (mm)	280 x 110	280 x 110	280 x 110	280 x 110	280 x 110	280 x 110	280 x 110
G (mm)	3	3	3	3	3	3	3
W (kg)	0,660	0,600	0,600	0,600	0,600	0,600	0,600



NR ART	15.364	15.364.01	15.364.02	15.364.04	15.365.01	15.365.02	15.365.11	15.365.12
H x L (mm)	275 x 65	∅ 50	∅ 50	275 x 65	150 x 55	110 x 40	330 x 175	330 x 175
G (mm)	3	5	5	3	8	8	3	3
W (kg)	0,260	0,050	0,050	0,260	0,500	0,300	0,920	0,920



NR ART	15.365.13	15.365.14	15.365.15	15.365.16	15.365.17	15.365.18
H x L (mm)	330 x 175	330 x 175	330 x 175	330 x 175	330 x 175	330 x 175
G (mm)	3	3	3	3	3	3
W (kg)	0,920	0,920	0,920	0,920	0,920	0,920

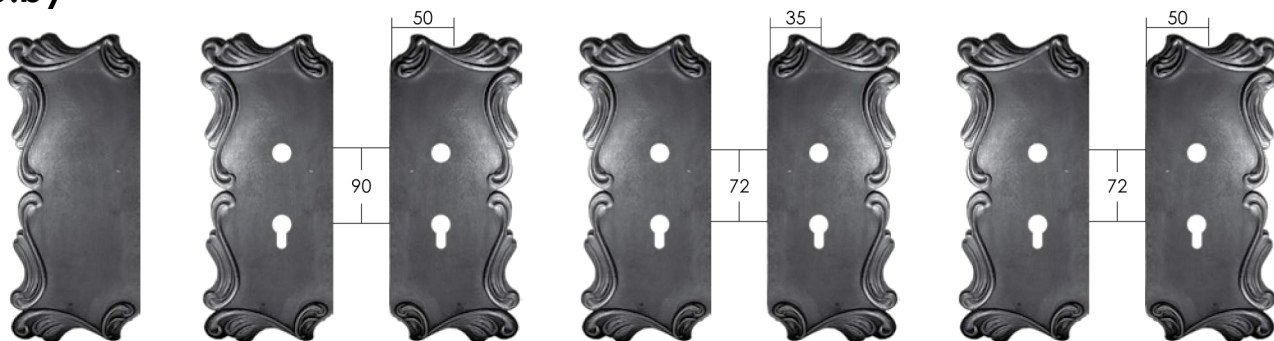

NR ART	15.366	15.366.01	15.366.02	15.366.03	15.366.04	15.366.05	15.366.06
H x L (mm)	315 x 135	315 x 135	315 x 135	315 x 135	315 x 135	315 x 135	315 x 135
G (mm)	3	3	3	3	3	3	3
W (kg)	0,900	0,900	0,900	0,900	0,900	0,900	0,900

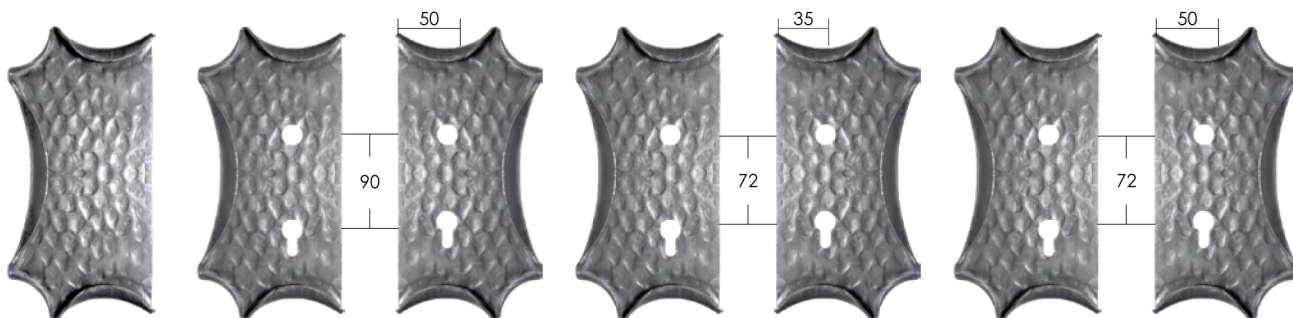

NR ART	15.367	15.367.01	15.367.02	15.367.03	15.367.04	15.367.05	15.367.06
H x L (mm)	280 x 140	280 x 140	280 x 140	280 x 140	280 x 140	280 x 140	280 x 140
G (mm)	4	4	4	4	4	4	4
W (kg)	0,800	0,800	0,800	0,800	0,800	0,800	0,800

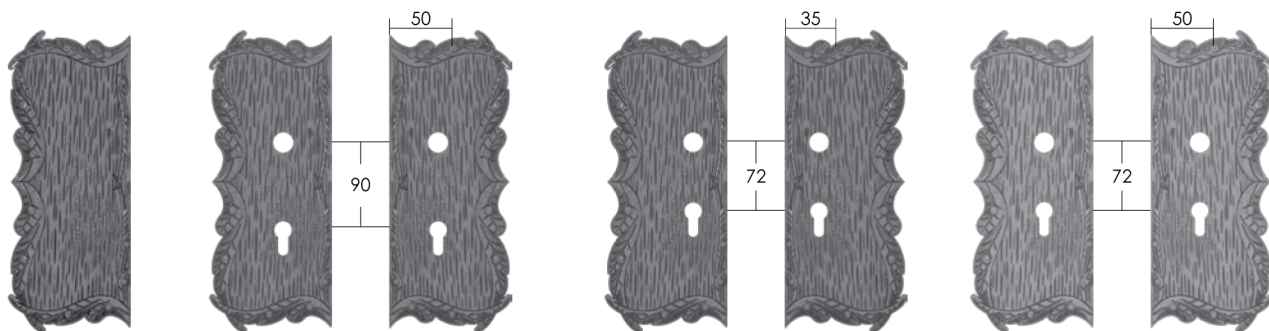

NR ART	15.368	15.368.01	15.368.02	15.368.03	15.368.04	15.368.05	15.368.06
H x L (mm)	315 x 130	315 x 130	315 x 130	315 x 130	315 x 130	315 x 130	315 x 130
G (mm)	2	2	2	2	2	2	2
W (kg)	0,500	0,500	0,500	0,500	0,500	0,500	0,500

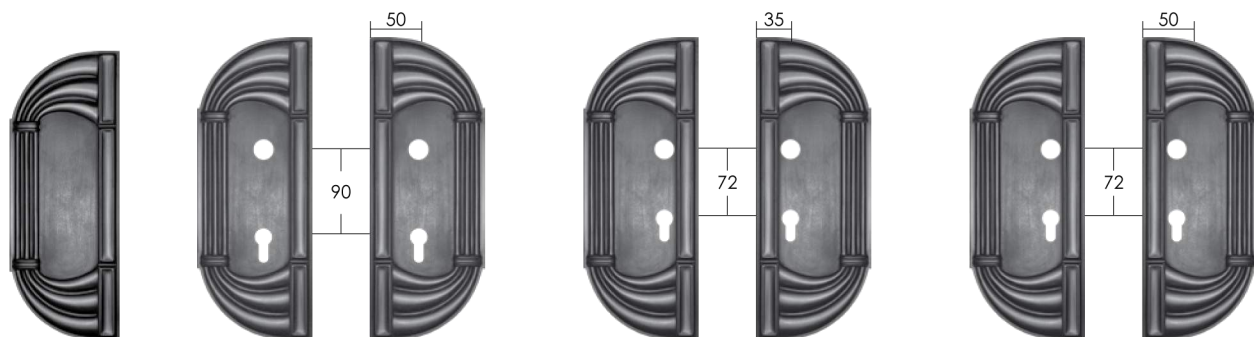

NR ART	15.369	15.369.01	15.369.02	15.369.03	15.369.04	15.369.05	15.369.06
H x L (mm)	315 x 120	315 x 120	315 x 120	315 x 120	315 x 120	315 x 120	315 x 120
G (mm)	2	2	2	2	2	2	2
W (kg)	0,550	0,550	0,550	0,550	0,550	0,550	0,550

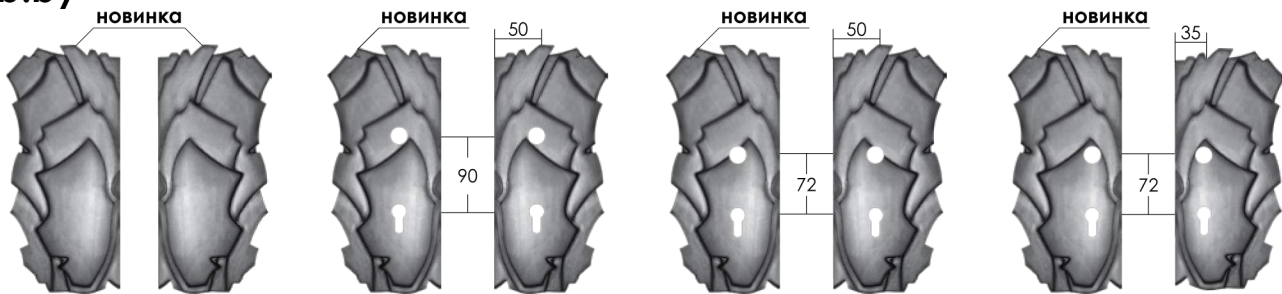

NR ART	15.370.01	15.370.02	15.370.03	15.370.04	15.370.05	15.370.06	15.370.09	15.370.10
H x L (mm)	295 x 135	295 x 135	295 x 135	295 x 135	295 x 135	295 x 135	295 x 135	295 x 135
G (mm)	2	2	2	2	2	2	2	2
W (kg)	0,540	0,540	0,530	0,530	0,530	0,530	0,530	0,530

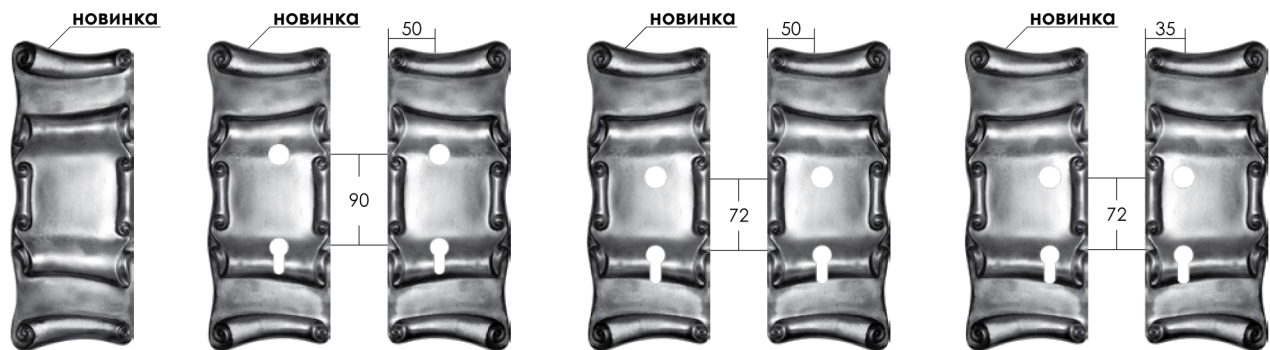

NR ART	15.372	15.372.01	15.372.02	15.372.03	15.372.04	15.372.07	15.372.08
H x L (mm)	300 x 120	300 x 120	300 x 120	300 x 120	300 x 120	300 x 120	300 x 120
G (mm)	2	2	2	2	2	2	2
W (kg)	0,530	0,520	0,520	0,520	0,520	0,520	0,520

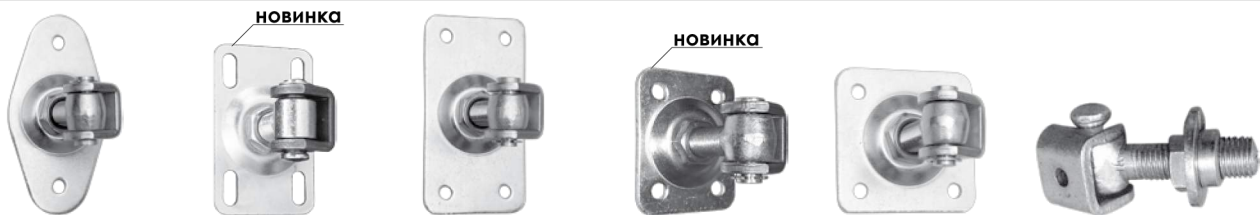

NR ART	15.250.01	15.250.02	15.250.03		15.250.07	15.250.08
H x L (mm)	160 x 85	120 x 75	160 x 85		100 x 100	40 x 100
M/ φ (mm)	M 20	M 20	M 20		M 20	M 20
W (kg)	0,740	0,660	0,840		0,750	0,500
NR ART			15.250.04	15.250.05	15.250.06	15.250.09
H x L (mm)			120 x 75	75 x 60	75 x 75	65
M/ φ (mm)			M 16	M 16	M 16	M 16
W (kg)			0,530	0,380	0,420	

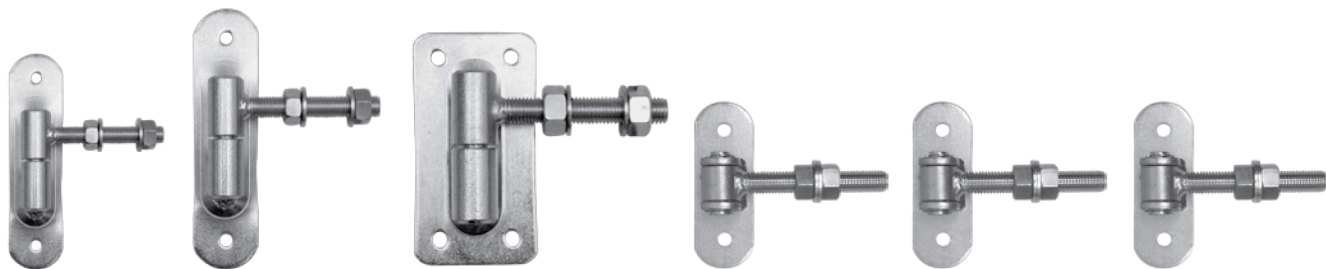

NR ART	15.250.12	15.250.16	15.250.18	15.253.16	15.253.18	15.253.20
H x L (mm)	145 x 40	200 x 50	160 x 85	130	130	130
M/ φ (mm)	M 12	M 16	M 18	M 16	M 18	M 20
φ (mm)	φ 24	φ 27	φ 30			
W (kg)	0,580	0,960	1,260	0,600	0,860	0,960



NR ART	H x L (mm)	M (mm)	W (kg)
15.254.16	75 x 35	M 16	0,120
15.254.18	80 x 60	M 18	0,220
15.254.20	80 x 60	M 20	0,220



NR ART	L (mm)	M (mm)	W (kg)
15.255.16	130	M 16	0,400
15.255.18	130	M 18	0,600
15.255.20	130	M 20	0,700



NR ART	L (mm)	M (mm)	W (kg)
15.256.16	160	M 16	0,500
15.256.18	180	M 18	0,700
15.256.20	180	M 20	0,800



NR ART	φ (mm)	H (mm)	W (kg)
15.401	φ 27	145	0,500
15.402	φ 35	190	1,100

NR ART	φ (mm)	H (mm)	W (kg)
15.412	φ 12	60	0,050
15.416	φ 16	66	0,100
15.420	φ 20	70	0,160
15.424	φ 24	80	0,300
15.427	φ 27	90	0,420
15.430	φ 30	100	0,520
15.435	φ 35	120	0,880
15.440	φ 40	120	1,140

NR ART	φ (mm)	H (mm)	W (kg)
15.420.01	φ 20	70	0,160
15.424.01	φ 24	80	0,280
15.427.01	φ 27	90	0,400
15.430.01	φ 30	100	0,560
15.435.01	φ 35	120	0,880
15.440.01	φ 40	120	1,160



NR ART	H x L (mm)	ВИНТ M/ L (mm)	W (kg)
15.261.16	80 x 80	M 16 x 50	0,460
15.261.20	100 x 100	M 20 x 50	0,680

NR ART	H x L (mm)	ВИНТ M/ L (mm)	W (kg)
15.262.16	80 x 80	M 16 x 50	0,460
15.262.20	100 x 100	M 20 x 50	0,620

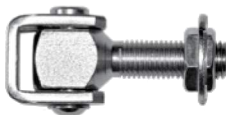

NR ART	L (mm)	ВИНТ M/ L (mm)	W (kg)
15.263.16	90	M 16 x 50	0,340
15.263.20	90	M 20 x 50	0,440

NR ART	L (mm)	ВИНТ M/ L (mm)	W (kg)
15.264.16	90	M 16 x 50	0,320
15.264.20	90	M 20 x 50	0,380



NR ART	L (mm)	ВИНТ M/ L (mm)	W (kg)
15.265.16	180	M 16 x 50	0,400
15.265.20	180	M 20 x 50	0,500

NR ART	L (mm)	ВИНТ M/ L (mm)	W (kg)
15.266.16	180	M 16 x 130	0,480
15.266.20	180	M 20 x 130	0,680



NR ART	φ (mm)	L (mm)	□ (mm)	W (kg)
15.441	φ 14	400	□ 35 x 4	0,480
15.442	φ 14	600	□ 35 x 4	0,700
15.443	φ 18	800	□ 40 x 5	1,340
15.444	φ 18	1000	□ 50 x 5	2,060
15.445	φ 20	1150	□ 60 x 6	3,380



NR ART	15.451	15.451.01	15.451.05	15.451.06	15.451.07	15.451.08	15.451.09
H x L (mm)	400 x 650	250 x 290	400	150	200	220	270
□ (mm)	□ 50 x 5	□ 35 x 4	□ 50 x 5	□ 35 x 5	□ 40 x 6	□ 50 x 6	□ 60 x 8
φ (mm)	φ 27	φ 14	φ 27	φ 14	φ 18	φ 18	φ 20
W (kg)	2,750	0,510	1,680	0,240	0,440	0,580	1,040



NR ART	φ (mm)	L (mm)	□ (mm)	NR ART	15.452	15.452.01	15.452.05	15.452.06
15.448	φ 14	500	□ 35 x 4	H x L (mm)	400 x 650	250 x 290	400	150
15.449	φ 18	700	□ 50 x 5	□ (mm)	□ 50 x 5	□ 35 x 4	□ 50 x 5	□ 35 x 5
				φ (mm)	φ 27	φ 14	φ 27	φ 14
				W (kg)	2,750	0,520	1,600	0,200



NR ART	15.453.01	15.454.01	15.454.02	15.455.01	15.455.02	15.455.03	15.455.04
H x L (mm)	200 x 50	220	240	150	200	220	270
□ (mm)	□ 50 x 5			□ 35 x 5	□ 40 x 6	□ 50 x 6	□ 60 x 8
φ (mm)	φ 27	φ 27	φ 35	φ 14	φ 18	φ 18	φ 20
W (kg)	0,800	0,920	1,720	0,240	0,460	0,600	1,100



РИГЕЛЯ	ОКРАШЕННЫЕ			НЕ ОКРАШЕННЫЕ	
NR ART	15.462	15.463	15.464	15.463.01	15.464.01
L (mm)	220	320	420	320	420
φ (mm)	φ 12	φ 14	φ 14	φ 14	φ 14
W (kg)	0,370	0,620	0,820	0,660	0,720

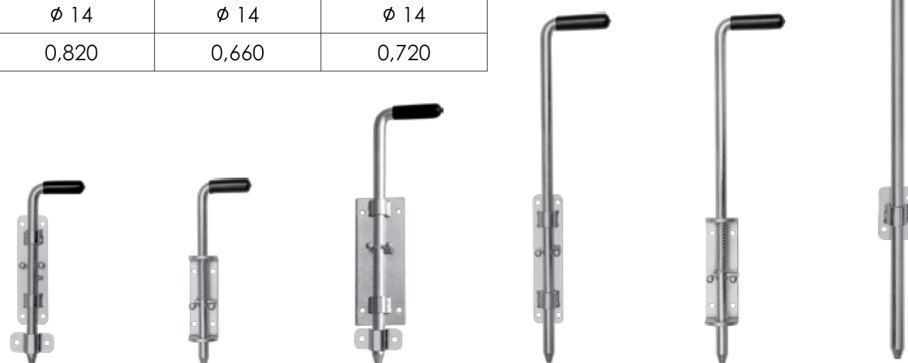

РИГЕЛЯ	ОЦИНКОВАННЫЕ					
NR ART	15.462.02	15.462.04	15.463.02	15.464.02	15.464.04	15.468
L (mm)	220	220	320	420	420	800
φ (mm)	φ 12	φ 12	φ 14	φ 14	φ 14	φ 14
W (kg)	0,340	0,400	0,660	0,720	0,840	1,250



ЗАСОБЫ	ОКРАШЕННЫЕ			НЕОКРАШЕННЫЕ
NR ART	15.472	15.473	15.478	15.473.01
L (mm)	270	340	210	340
φ (mm)	φ 16	φ 16	φ 14	φ 16
W (kg)	0,900	1,160	0,660	1,000

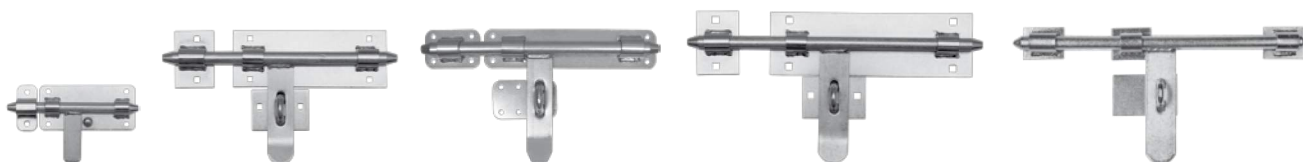

ЗАСОБЫ	ОЦИНКОВАННЫЕ				
NR ART	15.471.02	15.472.02	15.472.03	15.473.02	15.473.03
L (mm)	150	270	270	340	340
φ (mm)	φ 12	φ 16	φ 16	φ 16	φ 16
W (kg)	0,290	0,900	0,860	1,160	1,000

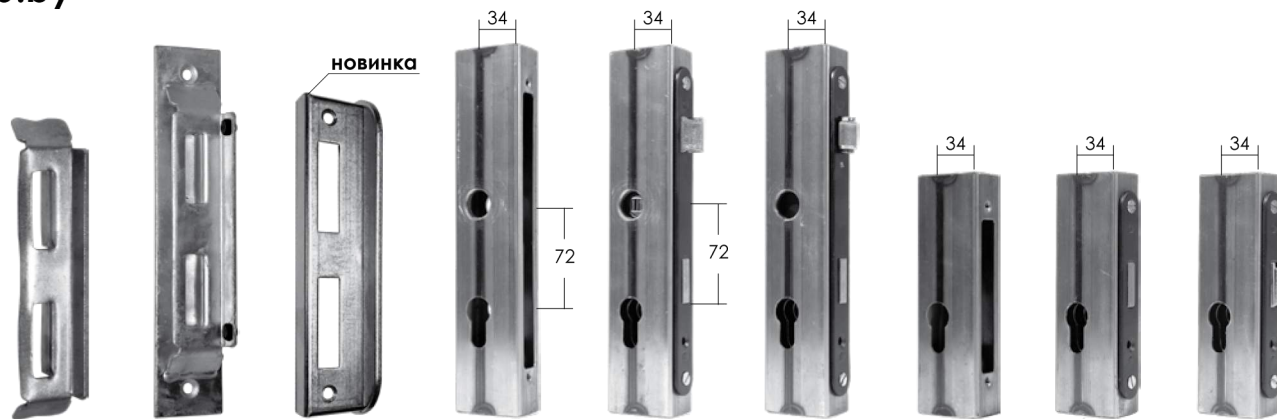

NR ART	15.530	15.531	15.532	15.533	15.533.01	15.533.02	15.534	15.534.01	15.534.02
□ (mm)			40	50 x 30	50 x 30	50 x 30	50 x 30	50 x 30	50 x 30
H (mm)	200	260	195	245	245	245	165	165	165
W (kg)	0,240	0,240	0,260	0,460	1,040	0,860	0,320	0,560	0,580

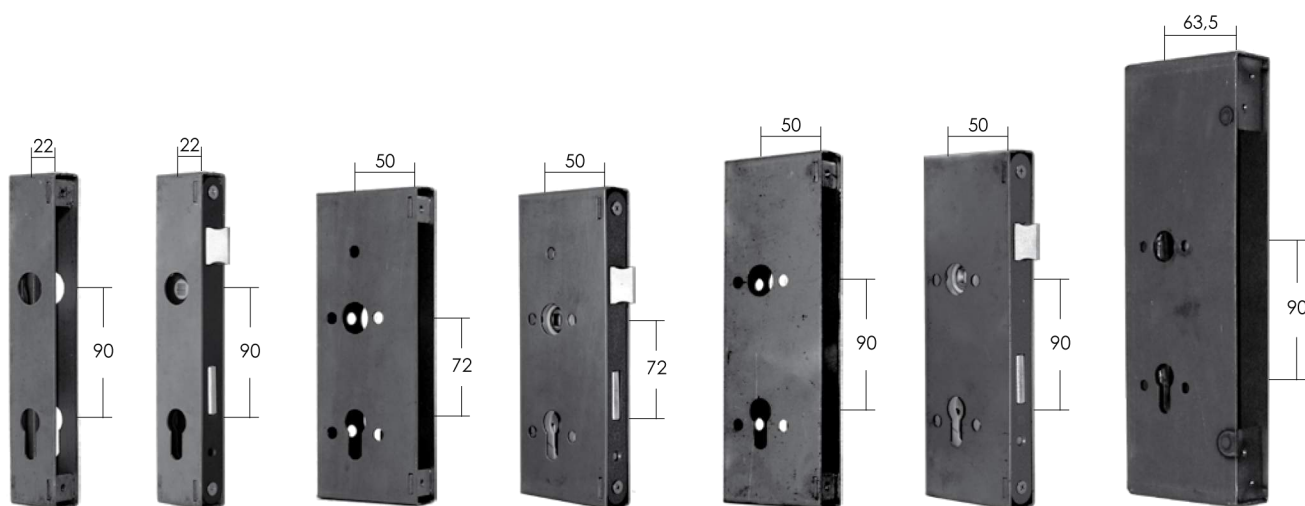

NR ART	15.634	15.634.01	15.638	15.638.01	15.639	15.639.01	15.640
□ (mm)	40 x 25	40 x 25	85 x 25	85 x 25	85 x 25	85 x 25	105 x 35
H (mm)	225	225	215	215	240	240	305
W (kg)	0,340	0,700	0,560	1,120	0,720	1,260	1,160

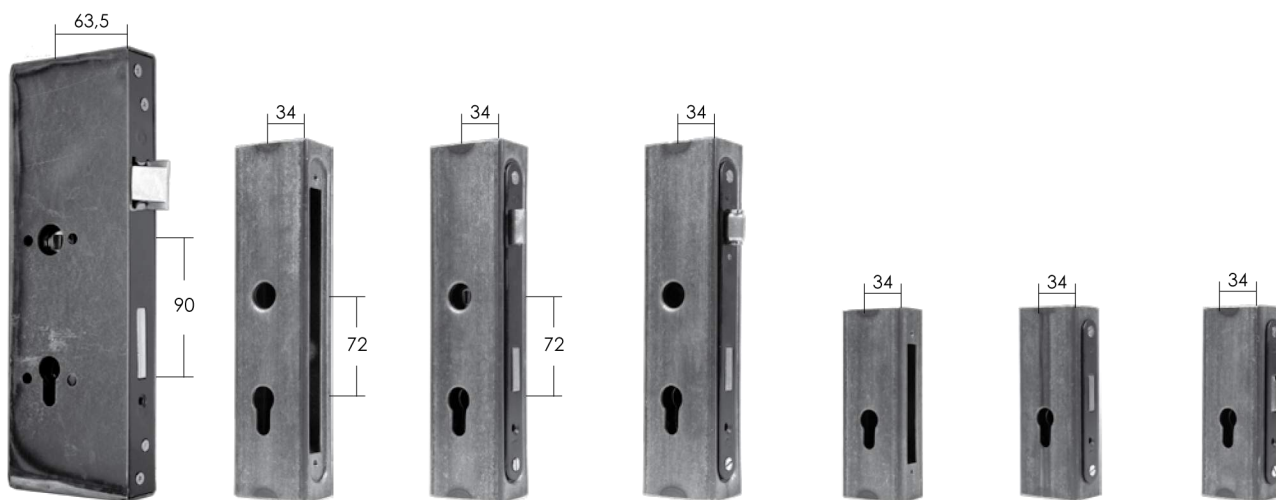

NR ART	15.640.01	15.641	15.641.01	15.641.02	15.642	15.642.01	15.642.02
□ (mm)	105 x 35	60 x 40	60 x 40	60 x 40	60 x 40	60 x 40	60 x 40
H (mm)	305	245	245	245	165	165	165
W (kg)	2,120	0,740	1,240	1,180	0,520	0,780	0,780

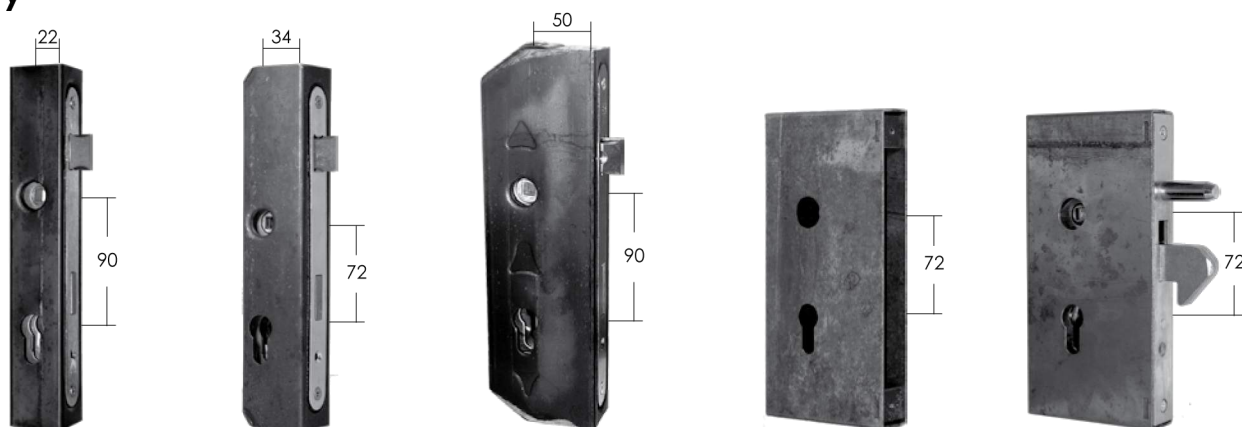

NR ART	15.644.01	15.645.01	15.648.01	15.649	15.649.01
□ (mm)	40 x 40	50 x 40	80 x 40	105 x 30	105 x 30
H (mm)	245	245	260	215	215
W (kg)	0,860	1,120	1,420	0,760	1,720



NR ART	15.650	15.650.01	15.650.02	15.650.04	15.651	15.651.01	15.651.03	15.651.05
	КАСЕТА ПОД ЭЛЕКТРОЗ.	КАСЕТА ПОД ЭЛЕКТРОЗ.	КАСЕТА С ЭЛЕКТРОЗАЩЕЛ. R4	КАСЕТА ПОД ЭЛЕКТРОЗ.	ЭЛЕКТРОЗАЩ. R3	ЭЛЕКТРОЗАЩ. R3 С БЛОКИРАТОР.	ЭЛЕКТРОЗАЩ. R3 С БЛОКИРАТОР. С ПАМЯТЬЮ	НАКЛАДКА УНИВЕРСАЛЬНАЯ
	ОЦИНКОВ.			ОЦИНКОВ.	U=10 ± 2V	U=10 ± 2V	U=10 ± 2V	ОЦИНКОВ.
□ (mm)	40 x 40	45 x 35	45 x 35	45 x 35	20 x 28,5	20 x 28,5	20 x 28,5	
H (mm)	280	255	255	255	90	90	90	148 x 25,5
W (kg)	0,940	1,000	1,350	1,000	0,200	0,200	0,200	0,070



NR ART	15.652	15.652.01	15.652.04	15.652.05	15.652.06	15.654	15.655	15.655.01
	КАСЕТА ПОД ЭЛЕКТРОЗ.	ЭЛЕКТРОЗАЩЕЛКА ШИРОКАЯ	НАКЛАДКА ДЛИННАЯ	НАКЛАДКА ДЛИННАЯ	НАКЛАДКА ДЛИННАЯ	ЭЛЕКТРОЗАЩ. R4	ЭЛЕКТРОЗАЩ. R5	ЭЛЕКТРОЗАЩ. R5 С БЛОКИРАТ.
			ОЦИНКОВ.	ОЦИНКОВ.	ОЦИНКОВ.	U=10 ± 2V	U=10 ± 2V	U=10 ± 2V
□ / L (mm)	34 x 90	27 x 55	29,5	25,5	25,5	21 x 29	16,5 x 29	16,5 x 29
H (mm)	102	77	250	250	250	68	67	67
W (kg)	0,340	0,240	0,125	0,100	0,090	0,160	0,130	0,130

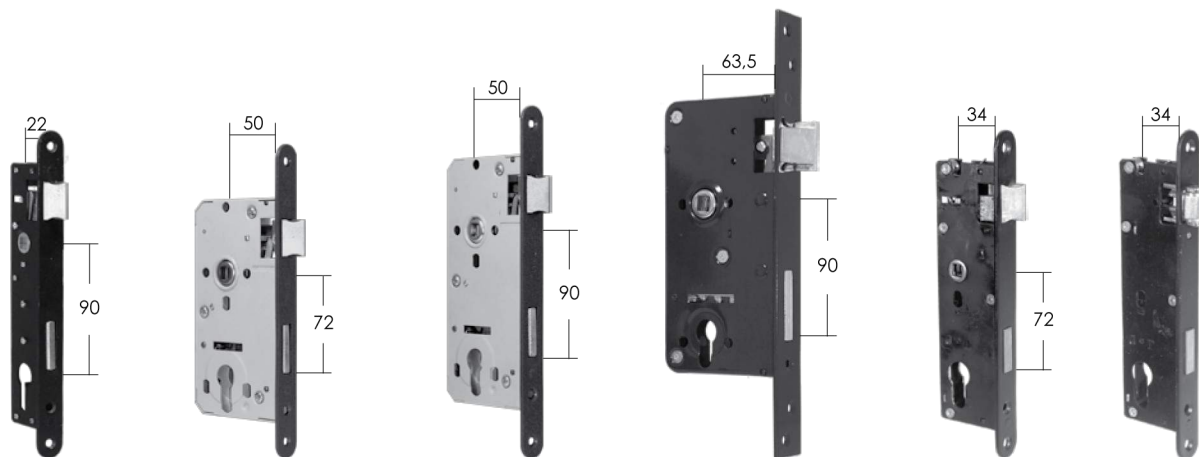

NR ART	15.664	15.668	15.669	15.670	15.671	15.672
H (mm)	220	210	235	300	220	220
W (kg)	0,360	0,540	0,600	1,000	0,600	0,540



NR ART	15.673	15.674	15.675	15.677	15.679
H (mm)	140	100	140	250	210
W (kg)	0,300	0,200	0,300	0,540	1,000



NR ART	15.503.02 КАПЕТКА 50	15.703 КАПЕТКА 70	15.703.01 КАПЕТКА 70	15.703.02 КАПЕТКА 70	15.703.06 КАПЕТКА 70	15.705 КАПЕТКА 70
W (kg)	0,600	2,500	4,320	1,520	1,250	4,640
NR ART	15.603.02 КАПЕТКА 60	15.803 WÓZEK JEZDNY 80	15.803.01 КАПЕТКА 80	15.803.02 КАПЕТКА 80	15.803.06 КАПЕТКА 80	15.805 КАПЕТКА 80
W (kg)	0,700	2,940	4,920	1,820	1,400	5,260



NR ART	15.705.01 КАПЕТКА 70			15.705.06 КАПЕТКА 70	15.705.07 КАПЕТКА 70
W (kg)	6,040			3,100	4,260
NR ART	15.805.01 КАПЕТКА 80	15.805.02 КАПЕТКА 80	15.805.03 КАПЕТКА 80	15.805.06 КАПЕТКА 80	15.805.07 КАПЕТКА 80
W (kg)	6,680	5,000	6,300	3,700	4,860

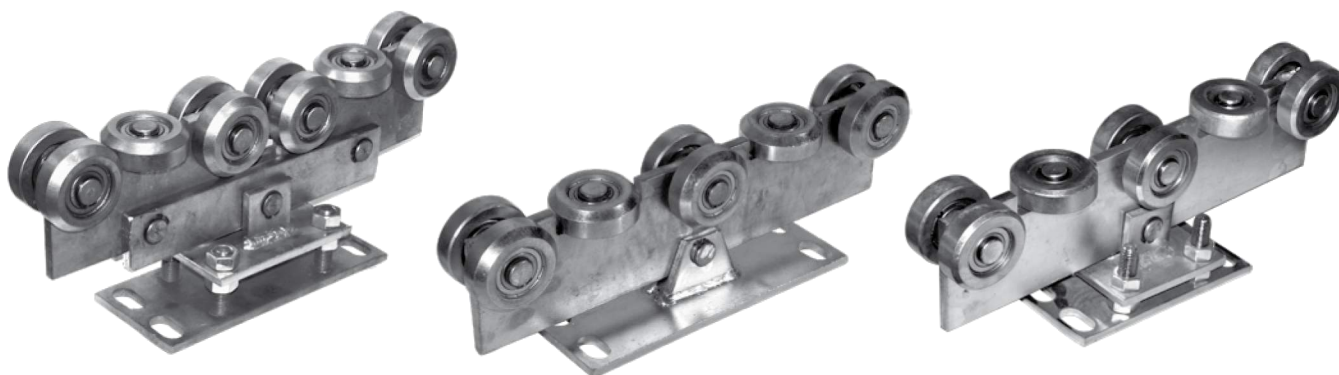

NR ART	15.805.04 КАПЕТКА 80	15.808 КАПЕТКА 80	15.808.01 КАПЕТКА 80
W (kg)	12,500	8,220	9,560



NR ART	15.820 РОЛИК	15.820.01 РОЛИК	15.821 РОЛИК	15.821.01 РОЛИК	15.825 РОЛИК ОПОРНЫЙ	15.826 УЛОВИТЕЛЬ НИЖНИЙ
φ/H x L (mm)	φ 60	φ 60	φ 68	φ 68	140	160 x 120
W (kg)	0,260	0,120	0,380	0,160	0,820	0,820



NR ART	15.830 ОТБОЙНИК	15.830.01 ОТБОЙНИК	15.830.02 ОТБОЙНИК	15.830.04 ОГРАНИЧИТЕЛЬ	15.830.05 ОГРАНИЧИТЕЛЬ	15.830.06 ОГРАНИЧИТЕЛЬ
H x L (mm)	35 x 155	55 x 155	80 x 155	44 x 120 x 100	48 x 160 x 130	90 x 90
φ (mm)						φ 90
W (kg)	1,940	2,380	3,200	0,300	0,700	0,350



NR ART	15.828 ОТБОЙНИК РЕЗИНОВЫЙ	15.829 ОТБОЙНИК РЕЗИНОВЫЙ	15.831 ОТБОЙНИК «Т»	15.831.01 ОТБОЙНИК «Т»	15.832 РОЛИК «V»	15.832.01 РОЛИК «V»	15.836 РОЛИК «U»
H x L (mm)	18 x φ 24	38 x 60	φ 70 x 20	φ 88 x 25	φ 70 x 23	φ 88 x 25	φ 88 x 25
φ (mm)	отw. φ 6/ φ 11	отw. φ 6/ φ 11					
W (kg)	0,010	0,050	0,420	0,800	0,420	0,800	0,800

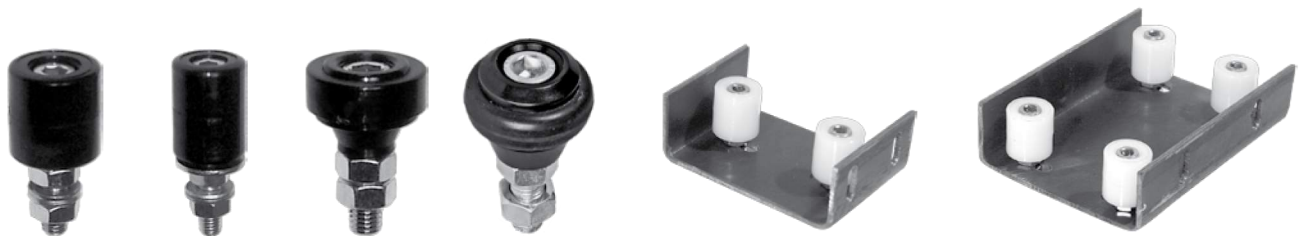

NR ART	15.833 РОЛИК	15.833.01 РОЛИК	15.833.02 РОЛИК	15.833.05 РОЛИК	15.834 НАПРАВЛЯЮЩАЯ ВЕРХНЯЯ	15.835 НАПРАВЛЯЮЩАЯ ВЕРХНЯЯ
φ x H (mm)	φ 33	φ 25	φ 42	φ 40	50 x 90	50 x 190
W (kg)	0,080	0,070	0,100	0,120	0,780	1,580



NR ART	15.837 УЛОВИТЕЛЬ 40	15.838 УЛОВИТЕЛЬ 60	15.839 УЛОВИТЕЛЬ 80	15.840 РОЛИК	15.840.02 РОЛИК	15.841
φ/ H (mm)	150 x 65	160 x 65	167 x 65	φ 33 X 150	φ 42 X 150	100 x 75 x 40
W (kg)	0,530	0,530	0,530	0,310	0,340	0,240



КОМПЛЕКТЫ ДЛЯ ОТКАТНЫХ ВОРОТ		
BX EURO для ворот массой до 300 кг	BX PLUS для ворот массой до 400 кг	BX STRONG для ворот массой до 800 кг
<ul style="list-style-type: none"> - двигатель BX-243 - блок управления ZN2 - приёмник ДУ - пульт 	<ul style="list-style-type: none"> - двигатель BX-74 - приёмник ДУ - фотоэлементы DIR 10 - пульт 	<ul style="list-style-type: none"> - двигатель BX-78 - приёмник ДУ - фотоэлементы DIR 10 - пульт



КОМПЛЕКТЫ ДЛЯ РАСПАШНЫХ ВОРОТ			
AMICO EURO длина створки до 2200 мм	FAST PLUS длина створки до 2300 мм	KRONO STANDARD длина створки до 3000 мм	KRONO PLUS длина створки до 3000 мм
<ul style="list-style-type: none"> - двигатель A18230 - приёмник ДУ - блок управления ZF 1N - фотоэлементы DIR 10 - пульт 	<ul style="list-style-type: none"> - двигатель F 7000 и F 7001 - приёмник ДУ - фотоэлементы DIR 10 - пульт 	<ul style="list-style-type: none"> - двигатель KR 300D и KR 300S - приёмник ДУ - блок управления ZF 1N - фотоэлементы DIR 10 - пульт 	<ul style="list-style-type: none"> - двигатель KR 310D и KR 310S - приёмник ДУ - блок управления ZA 3N - фотоэлементы DIR 10 - пульт Двигатели со встроенными концевыми выключателями



ZESTAWY DO BRAM GARAŻOWYCH			
HOME HG 600 - для гаражных ворот площадью до 10 м ²	HOME HG 1000 - для гаражных ворот площадью до 14 м ²	VER - 700 сила тяги 850 N	VER - 900 сила тяги 550 N
<ul style="list-style-type: none"> - двигатель HG 600 сила тяги 600 N - шина с цепью 3300 мм - пульт четырёхканальный SP4 с динамическим кодом 	<ul style="list-style-type: none"> - двигатель HG 1000 сила тяги 1000 N - шина с цепью 3300 мм - пульт четырёхканальный SP4 с динамическим кодом 	<ul style="list-style-type: none"> - двигатель V-700E - приёмник ДУ AF43S - пульт TAM 432 SA 	<ul style="list-style-type: none"> - двигатель V-900E - приёмник ДУ AF43S - пульт TAM 432 SA



ШИНА С ЦЕПЬЮ ДЛЯ ГАРАЖНЫХ ВОРОТ К ДВИГАТЕЛЯМ VER 700 И VER 900		
NR ART	высота наклона до	высота проёма до
V0679	2400 мм	2250 мм
V0682	2900 мм	2750 мм
V0683	3400 мм	3250 мм



NR ART	15.850	15.850.01	C8	C10	CGZF	CGZF-40
φ / H (mm)	φ 80	φ 68	1000	1000	1000 (3 x 330)	400
G / П (mm)	18 зубьев	15 зубьев	П 8	П 10	20 x 40	20 x 46
W (kg)	0,900	0,900	1,640	2,060	3 x 0,550	



TAM 432 SA	TOP 432 EV	TOP 434 EV	SP 2	SP 4	TOP A433N	KIARO N led
ПОСТОЯННЫЙ КОД	ПОСТОЯННЫЙ КОД	ПОСТОЯННЫЙ КОД	ДИНАМИЧЕСКИЙ КОД	ДИНАМИЧЕСКИЙ КОД	433 MHz	230V/2W



NR ART	16.010	16.010.01	16.015.01	16.085.01
H x L (mm)	75 x 145	75 x 145	75 x 145	75 x 145
W (kg)	0,550	0,540	0,460	0,620



NR ART	16.306.01	16.306.02	16.306.03
H x L (mm)	50 x 155	50 x 125	120 x 135
W (kg)	0,900	0,800	0,850



NR ART	16.306.04	16.306.05	16.306.06	16.306.07
H x L (mm)	90	65	65	70
φ (mm)	φ 65	φ 65	φ 70	φ 68
W (kg)	0,480	0,420	0,420	0,440



NR ART	16.306.08	16.306.11	16.306.12	16.306.13
H x L (mm)	50 x 130	50 x 170	50 x 130	50 x 110
W (kg)	0,660	0,900	0,740	0,760



NR ART	16.306.14	16.306.15	16.306.18	16.306.19
H x L (mm)	50 x 135	50 x 130	40 x 110	45 x 85
φ (mm)			φ 68	φ 68
W (kg)	0,750	0,550	0,420	0,280



NR ART	16.320	16.321	16.322	16.324
H x L (mm)	125	93 x 65	93 x 65	125
φ (mm)				
W (kg)	0,500	0,250	0,500	0,500

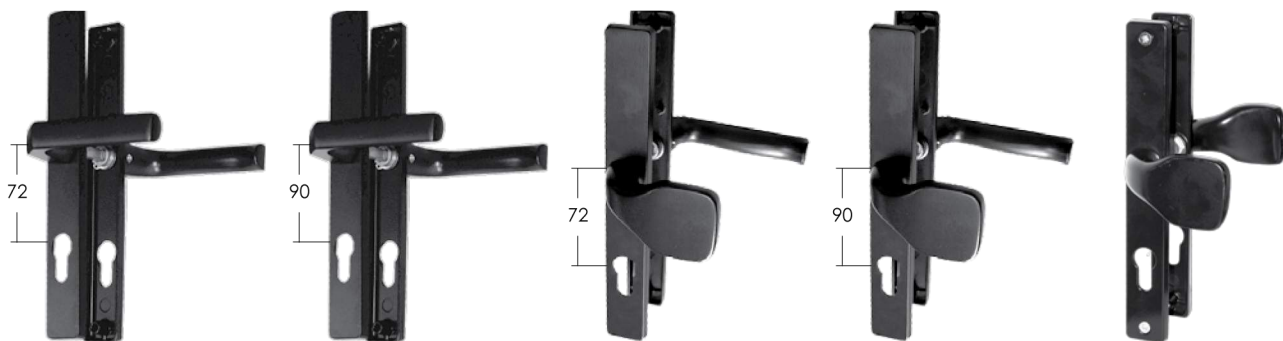

NR ART	16.325	16.326	16.328	16.329	16.330
H x L (mm)	30 x 240	30 x 240	30 x 240	30 x 240	30 x 240
A (mm)	72	90	72	90	
W (kg)	0,600	0,600	0,600	0,600	0,440



NR ART	ЦВЕТ	H x L (mm)	G (mm)	W (kg)
16.034	красный	410 x 255	90	1,860
16.035	коричневый	410 x 255	90	1,860
16.036	серый	410 x 255	90	1,860
16.037	зелёный	410 x 255	90	1,860
16.038	граффит	410 x 255	90	1,860
16.039	чёрный	410 x 255	90	1,860
16.040	красный	470 x 298	95	2,300
16.041	коричневый	470 x 298	95	2,300
16.042	серый	470 x 298	95	2,300
16.043	зелёный	470 x 298	95	2,300
16.044	граффит	470 x 298	95	2,300
16.045	чёрный	470 x 298	95	2,300

НОВИНКА



NR ART	ЦВЕТ	H x L (mm)	G (mm)	W (kg)
16.150	чёрный	290 x 360	90	3,500
16.151	серый	290 x 360	90	3,500
16.152	коричневый	290 x 360	90	3,500
16.153	чёрно-белый	290 x 360	90	3,500
16.154	серо-чёрный	290 x 360	90	3,500

НОВИНКА

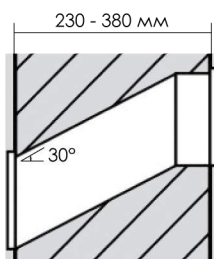

NR ART	ЦВЕТ	H x L (mm)	G (mm)	W (kg)
16.200	хром	110 x 300	240 - 405	3,000
16.201	чёрный	110 x 300	240 - 405	3,000
16.202	граффит	110 x 300	240 - 405	3,000
16.203	золотой	110 x 300	240 - 405	3,000
16.204	медный	110 x 300	240 - 405	3,000
16.205	зелёный	110 x 300	240 - 405	3,000
16.206	красный	110 x 300	240 - 405	3,000

НОВИНКА



НОВИНКА



НОВИНКА



НОВИНКА



НОВИНКА



NR ART	16.210	16.230	16.240	16.270	16.290
H x L (mm)	480 x 320	460 x 390	460 x 390	345 x 365	280 x 245
G (mm)	120	105	105	110	70
W (kg)	6,000	5,000	5,000	3,600	3,000



NR ART	16.211	16.231	16.243	16.274
H x L (mm)	480 x 320	460 x 390	460 x 390	345 x 365
G (mm)	120	105	105	110
W (kg)	6,000	5,000	5,000	3,600



NR ART	16.410.01	16.410.02	16.410.03	16.410.04	16.410.05
H (mm)	700	700	820	700	880
W (kg)	6,000	5,300	9,110	5,800	11,100



NR ART	16.410.06	16.410.07	16.410.08	16.410.09	16.410.10
H x L (mm)	340 x 405	390 x 385	410 x 430	385 x 390	465 x 435
W (kg)	2,600	2,530	4,600	3,000	2,600



NR ART	17.901.01	17.901.02	17.902.01
H x L (mm)	400	670	790

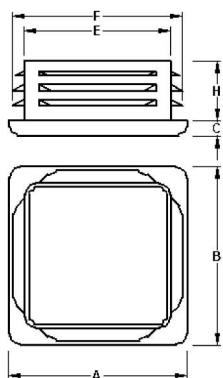

NR ART	□ A x B (mm)	Gr. pr (mm)	H (mm)	E (mm)	F (mm)
17.015	□ 15 x 15	1,0 - 2,0	11,5	10,0	14,5
17.016	□ 16 x 16	1,0 - 2,0	11,0	10,8	14,8
17.020	□ 20 x 20	1,0 - 2,5	14,0	12,9	18,6
17.025	□ 25 x 25	1,0 - 2,5	15,0	18,0	23,2
17.030	□ 30 x 30	1,0 - 2,5	15,0	23,0	28,2
17.035	□ 35 x 35	1,0 - 2,5	15,0	27,4	33,7
17.040	□ 40 x 40	1,2 - 3,0	18,0	33,1	38,4
17.050	□ 50 x 50	1,5 - 3,0	18,0	43,7	48,0
17.060	□ 60 x 60	1,5 - 3,0	18,0	53,0	58,3
17.070	□ 70 x 70	1,5 - 4,0	18,5	60,8	67,3
17.080	□ 80 x 80	1,5 - 5,0	22,0	66,8	77,4
17.100	□ 100 x 100	2,0 - 5,0	23,0	86,0	96,0
17.120	□ 120 x 120	3,0 - 6,5	25,0	109,0	116,0

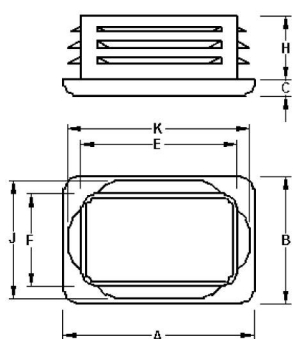

NR ART	▭ A x B (mm)	Gr. pr (mm)	H (mm)	▭ E x F (mm)	▭ K x J (mm)
17.210.20	▭ 20 x 10	1,2 - 1,5	12,0	▭ 15,8 x 5,6	▭ 17,7 x 7,6
17.215.25	▭ 25 x 15	1,0 - 2,0	12,9	▭ 19,9 x 10,3	▭ 23,9 x 13,9
17.218.30	▭ 18 x 30	1,0 - 3,0	14,0	▭ 22,6 x 11,0	▭ 28,5 x 16,5
17.220.30	▭ 30 x 20	1,0 - 3,0	14,0	▭ 22,5 x 13,0	▭ 28,5 x 18,5
17.220.40	▭ 40 x 20	1,0 - 3,0	14,0	▭ 32,6 x 13,0	▭ 38,5 x 18,5
17.220.50	▭ 50 x 20	1,0 - 3,0	15,0	▭ 42,8 x 13,0	▭ 49,0 x 18,7
17.220.60	▭ 60 x 20	1,5 - 3,0	14,0	▭ 54,0 x 14,0	▭ 58,0 x 18,2
17.220.80	▭ 80 x 20	1,5 - 3,0	17,5	▭ 74,3 x 12,9	▭ 78,4 x 18,0
17.225.40	▭ 40 x 25	1,5 - 3,0	13,0	▭ 35,2 x 19,8	▭ 38,0 x 23,4
17.225.50	▭ 50 x 25	1,5 - 3,0	16,0	▭ 40,5 x 15,8	▭ 47,2 x 22,8
17.227.40	▭ 40 x 27	1,5 - 3,0	14,0	▭ 32,6 x 19,8	▭ 38,2 x 25,4
17.230.40	▭ 40 x 30	1,5 - 3,0	14,0	▭ 32,4 x 21,7	▭ 37,3 x 28,6
17.230.50	▭ 50 x 30	1,5 - 3,0	16,0	▭ 42,5 x 22,8	▭ 47,5 x 27,6
17.230.60	▭ 60 x 30	1,5 - 3,0	16,0	▭ 52,0 x 22,5	▭ 58,0 x 27,8
17.240.60	▭ 60 x 40	1,5 - 3,0	17,0	▭ 50,5 x 30,8	▭ 58,0 x 38,2
17.240.80	▭ 80 x 40	1,5 - 3,0	17,0	▭ 68,0 x 28,0	▭ 77,2 x 37,6
17.250.100	▭ 100 x 50	2,0 - 4,0	20,0	▭ 90,0 x 39,3	▭ 98,5 x 46,3
17.260.80	▭ 80 x 60	1,5 - 4,0	20,0	▭ 66,0 x 46,0	▭ 77,1 x 57,5

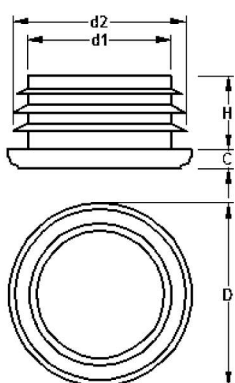

NR ART	∅ D (mm)	Gr. pr (mm)	H (mm)	∅ d1 (mm)	∅ d2 (mm)
17.300	∅ 21,3 (1/2")	2,5 - 3,5	20,0	∅ 12,4	∅ 16,8
17.301	∅ 26,9 (3/4")	2,0 - 3,2	20,0	∅ 19,4	∅ 23,4
17.302	∅ 33,7 (1")	2,5 - 3,2	20,0	∅ 24,8	∅ 28,5
17.303	∅ 42,4 (1 1/4")	2,5 - 3,6	15,0	∅ 33,7	∅ 38,4
17.304	∅ 48,3 (1 1/2")	2,0 - 3,6	17,5	∅ 37,8	∅ 45,5
17.305	∅ 60,3 (2")	2,0 - 3,6	18,0	∅ 49,0	∅ 57,6
17.306	∅ 76,1 (2 1/2")	3,0 - 4,0	22,0	∅ 63,8	∅ 71,3
17.307	∅ 90,2 (3")	3,0 - 5,0	21,0	∅ 76,6	∅ 86,5
17.316	∅ 16	1,0 - 1,5	12,7	∅ 10,3	∅ 15,0
17.318	∅ 18	1,0 - 1,5	14,3	∅ 12,4	∅ 17,0
17.320	∅ 20	1,0 - 1,5	14,9	∅ 14,5	∅ 19,4
17.325	∅ 25	1,0 - 2,0	15,0	∅ 18,7	∅ 23,7

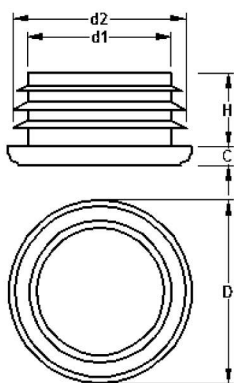

NR ART	∅ D (mm)	Gr. pr (mm)	H (mm)	∅ d1 (mm)	∅ d2 (mm)
17.330	∅ 30	1,0 - 2,0	15,0	∅ 25,0	∅ 29,0
17.332	∅ 32	1,0 - 2,0	15,0	∅ 25,3	∅ 30,0
17.335	∅ 35	1,0 - 2,0	15,2	∅ 25,8	∅ 32,8
17.340	∅ 40	1,5 - 2,5	15,0	∅ 32,0	∅ 38,8
17.350	∅ 50	1,2 - 2,5	18,0	∅ 42,5	∅ 48,5
17.360	∅ 60	1,5 - 3,0	19,5	∅ 50,9	∅ 58,4
17.370	∅ 70	1,5 - 4,0	22,1	∅ 59,0	∅ 67,2
17.376	∅ 76	1,5 - 2,5	21,8	∅ 64,0	∅ 74,0
17.376.01	∅ 76	3,0 - 4,0	22,0	∅ 63,7	∅ 71,3

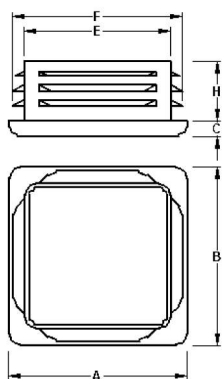

NR ART	□ A x B (mm)	Gr. pr (mm)	H (mm)	E (mm)	F (mm)
17.615	□ 15 x 15	1,0 - 2,0	12,0	10,0	13,4
17.620	□ 20 x 20	1,0 - 2,5	14,0	12,9	18,6
17.625	□ 25 x 25	1,0 - 2,5	14,0	20,0	24,2
17.630	□ 30 x 30	1,0 - 2,5	15,0	23,0	28,2
17.640	□ 40 x 40	1,5 - 3,0	17,0	31,0	37,4
17.650	□ 50 x 50	1,5 - 3,0	19,7	40,4	47,0
17.660	□ 60 x 60	1,5 - 3,0	18,0	52,7	58,4
17.680	□ 80 x 80	2,0 - 5,0	22,0	67,2	77,4
17.700	□ 100 x 100	2,0 - 5,0	23,0	86,3	96,5

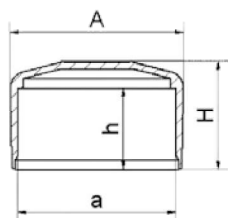

NR ART	a (mm)	A (mm)	H (mm)	h (mm)
17.1015	□ 15	18,7	21,0	16,0
17.1018	□ 18	21,6	21,9	17,0
17.1020	□ 20	24,0	24,0	19,0
17.1030	□ 30	33,7	29,3	23,8
17.1040	□ 40	45,5	32,0	21,0
17.1050	□ 50	54,0	27,0	21,0
17.1060	□ 60	65,0	31,0	21,0
17.1070	□ 70	77,0	35,0	25,0
17.1080	□ 80	87,0	36,0	26,0
17.1100	□ 100	103,0	31,0	21,0

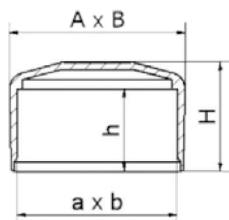

NR ART	▭ a x b (mm)	▭ A x B (mm)	H (mm)	h (mm)
17.1218.30	▭ 18 x 30	▭ 20,5 x 30,1	24,0	19,0
17.1220.30	▭ 20 x 30	▭ 23,5 x 33,5	24,0	19,0
17.1240.60	▭ 40 x 60	▭ 45 x 65	30,5	21,0
17.1240.80	▭ 40 x 80	▭ 45 x 85	31,2	21,2
17.1260.80	▭ 60 x 80	▭ 65 x 85	33,0	21,0

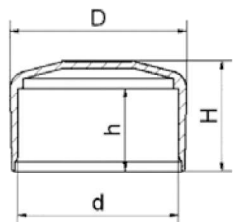

NR ART	∅ d (mm)	D (mm)	H (mm)	h (mm)
17.1303	∅ 42,4 (1 1/4")	46,8	33,5	24,3
17.1304	∅ 48,3 (1 1/2")	53,0	33,0	24,0
17.1305	∅ 59,8 (2")	65,0	40,0	27,0
17.1306	∅ 75,8 (2 1/2")	79,5	40,0	27,0
17.1338	∅ 37,8	42,5	29,8	22,5
17.1340	∅ 39,8	46,6	29,8	22,5
17.1342	∅ 41,7	46,6	34,4	24,4
17.1344	∅ 44,3	48,8	34,5	24,7
17.1351	∅ 50,6	53,3	33,0	24,0

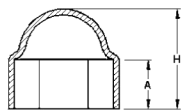

NR ART	φ D (mm)	РЕЗЬБА/КЛЮЧ	H (mm)	B (mm)	A (mm)
17.385	φ 10,6	M 5 - 8	9,5	7,9	6,0
17.386	φ 13,2	M 6 - 10	13,4	9,9	7,3
17.388	φ 17,6	M 8 - 13	16,5	12,9	8,7
17.390	φ 21,6	M 10 - 17	20,3	16,9	10,1
17.392	φ 23,6	M 12 - 19	21,9	18,9	11,4
17.394	φ 27,4	M 14 - 22	24,2	21,9	12,5
17.396	φ 29,6	M 16 - 24	27,2	23,9	14,0
17.398	φ 29,6	M 18 - 27	30,3	26,5	17,4

17.420.01 M 20 / H 60 	17.420.02 M 20 / H 88 	17.424.01 M 24 / H 70 	17.424.02 M 24 / H 90
17.427.01 M 27 / H 80 	17.427.02 M 27 / H 100 	17.430.02 M 30 / H 100 	

NR ART	ТИП	КЛЮЧ	B (mm)	H (mm)	A (mm)	E (mm)	F (mm)
17.420.01	M 20 / H 60	30	29,3	65,0	19,0	----	----
17.420.02	M20 / H 88 2 x гайки	30	29,3	88,0	19,0	35,5	21,5
17.424.01	M24 / H 70	36	35,2	75,0	21,0	46,6	5,0
17.424.02	M24 / H 90 2 x гайки	36	35,2	94,0	21,0	46,6	24,0
17.427.01	M27 / H 80	41	39,9	83,0	24,0	51,3	5,0
17.427.02	M27 / H 100 2 x гайки	41	39,9	99,5	24,0	51,3	27,0
17.430.02	M30 / H 100 2 x гайки	46	51,5	99,5	51,0	59,0	5,0

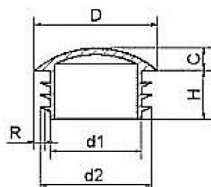

NR ART	φ D (mm)	R (mm)	C (mm)	H (mm)	φ d1 (mm)	φ d2 (mm)
17.420	φ 20	1 - 2	5	11,8	φ 15,5	φ 19
17.425	φ 25	1 - 2	5	12,0	φ 18,8	φ 24
17.428	φ 28	1 - 2	5	14,0	φ 21,2	φ 27
17.432	φ 32	1 - 2	5	14,6	φ 26,3	φ 30,2

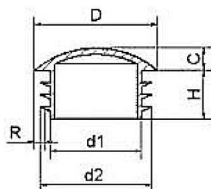

NR ART	φ D (mm)	R (mm)	C (mm)	H (mm)	φ d1 (mm)	φ d2 (mm)
17.520	φ 20	1,5 - 2,5	10,0	15,5	φ 12,0	φ 18,3
17.542	φ 42,4 (1 1/4")	1,5 - 2,5	21,2	25,0	φ 36,5	φ 32,3
17.548	φ 48,3 (1 1/2")	1,5 - 2,5	24,1	25,0	φ 38,2	φ 42,4
17.550	φ 49,8	1,5 - 2,5	25,5	29,5	φ 39,0	φ 47,2
17.560	φ 60,3	1,5 - 2,5	30,1	25,0	φ 49,3	φ 53,6

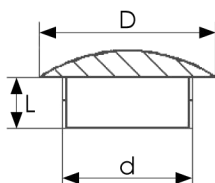

NR ART	φ d (mm)	D (mm)	L (mm)
17.804	φ 4,0	φ 8,0	3,0
17.805	φ 5,0	φ 8,0	5,0
17.806	φ 6,0	φ 10,0	5,4
17.808	φ 8,0	φ 13,0	6,0
17.810	φ 10,0	φ 13,0	6,3

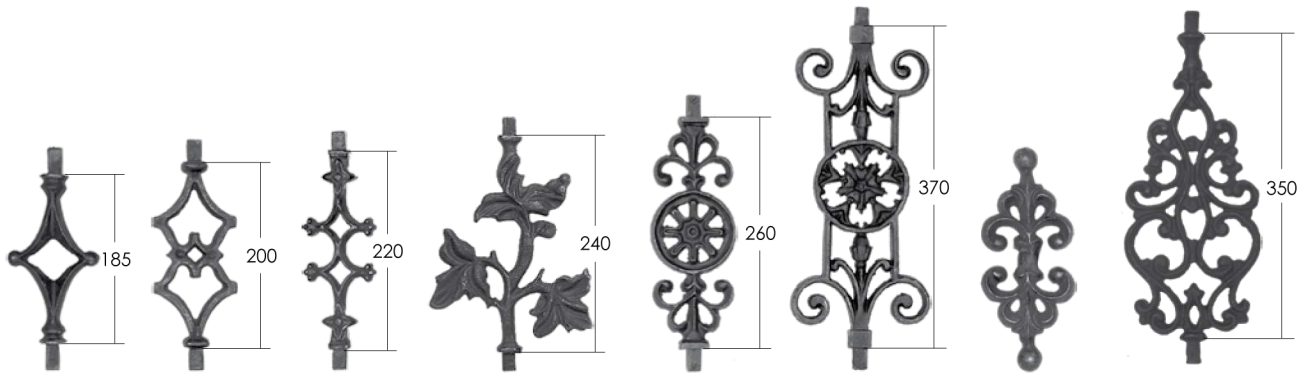

NR ART	17.701	17.703	17.704	17.705	17.706	17.707	17.708	17.709
H x L (mm)	240 x 100	245 x 90	260 x 82	280 x 180	310 x 95	400 x 155	250 x 100	390 x 145
□ (mm)	□ 15 x 15	□ 15 x 15	□ 15 x 15	□ 15 x 15	□ 15 x 15	□ 15 x 15		□ 15 x 15
W (kg)	0,760	0,480	0,660	0,480	0,300	0,200	0,110	2,020



NR ART	17.713	17.714	17.715	17.727	17.728
H x L (mm)	270 x 235	160 x 150	250 x 140	250 x 340	100 x 490
□ (mm)	□ 20	□ 20	□ 20		□ 14 x 14
W (kg)	2,560	0,900	1,500	1,840	2,600



NR ART	17.731	17.733	17.740	17.743
H x L (mm)	630 x 520	780 x 580	750 x 550	690 x 585
W (kg)	15,000	17,200	15,300	15,200

КОВАНЫЕ ЗАКЛЁПКИ

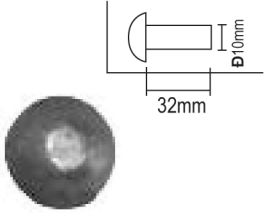

Art. 72/11
 Ø20.5xH.40mm

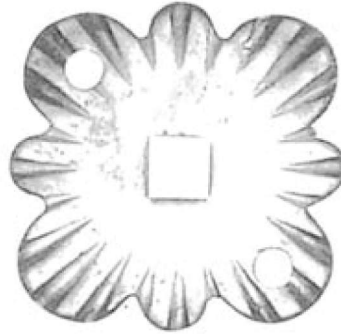

Art. 9C/03
 H.92xL.92mm
 ≠ 4mm
 □16.5mm

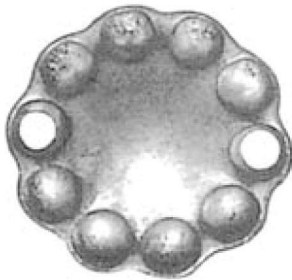

Art. 9C/01
 Φ 80mm
 ≠ 4mm



H.900xL.260mm
 Art. 20B/17 Φ 12mm



Art. 33/02
 H.200xL.770mm
 16x4mm

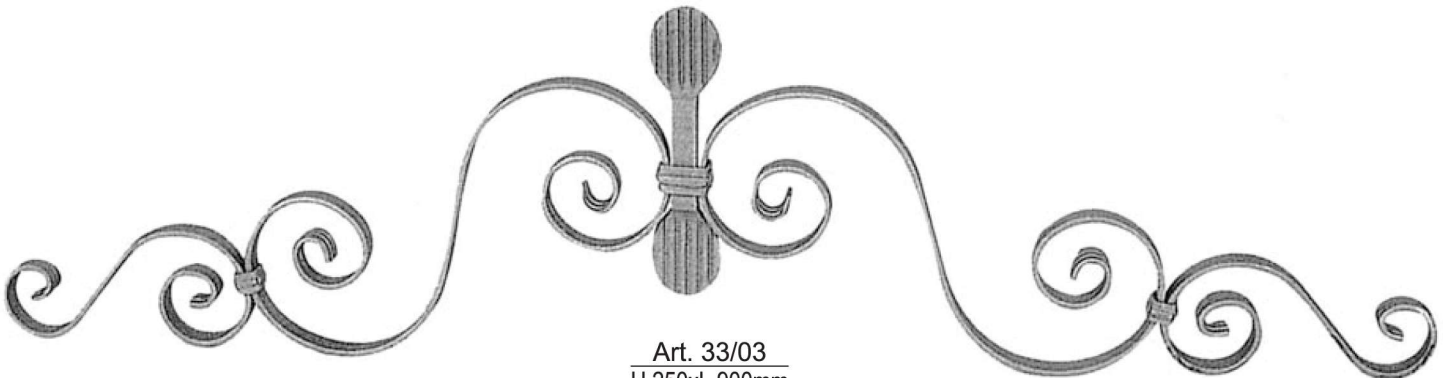

Art. 33/03
 H.250xL.900mm
 16x4mm

Вставки для перил

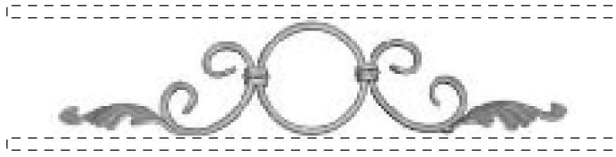

Art. 49/03

H.100xL.445mm 12x6mm

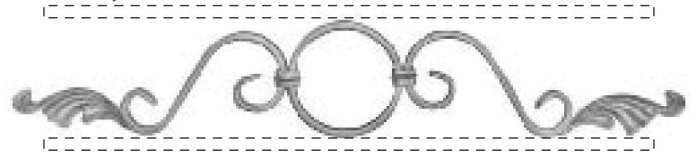

Art. 49/04

H.100xL.595mm 12x6mm

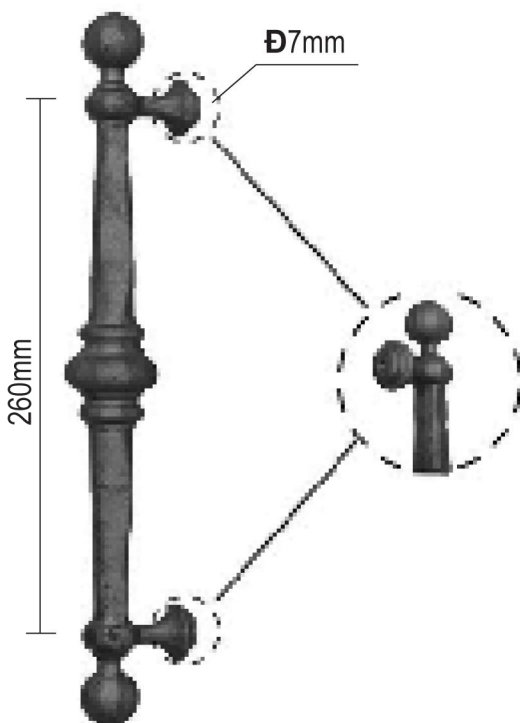

Art. 71/03

H.350mm Ø30mm

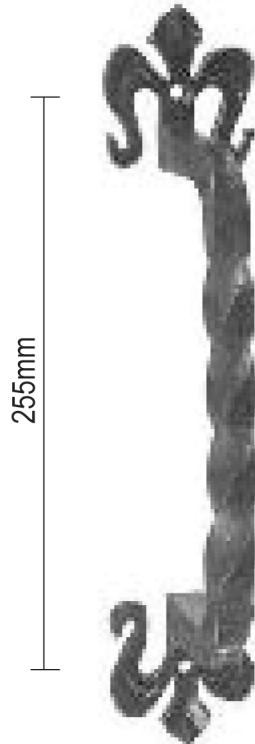

Art. 71/06

H.330xL.85mm

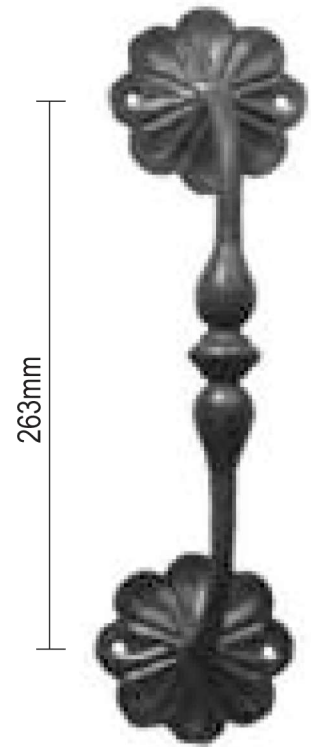

Art. 71/07

H.355xL.75mm



NR ART	16.090 патина золото	16.091 патина медь	16.092 патина серебро	16.093 патина тёмная зелень	16.094 патина туркус
Poj. (L)	0,22 L	0,22 L	0,22 L	0,22 L	0,22 L
W (kg)	0,280	0,280	0,280	0,280	0,280



NR ART	16.095 патина синяя	16.096 патина жёлтая	16.097 патина красная	16.098 патина белая	16.099 патина зелёная
Poj. (L)	0,22 L	0,22 L	0,22 L	0,22 L	0,22 L
W (kg)	0,280	0,280	0,280	0,280	0,280



NR ART	17.900	17.903	17.907	17.908
H x L (mm)	1420 x 650 x 460	1300 x 600 x 460	1190 x 600 x 550	1270 x 830 x 670
W (kg)	6,700	6,000	6,000	7,240



NR ART	17.909	17.913	17.914	17.921
H x L (mm)	1340 x 510 x 460	810 x 350	810 x 330	1180 x 610
W (kg)	5,720	1,860	1,660	7,700

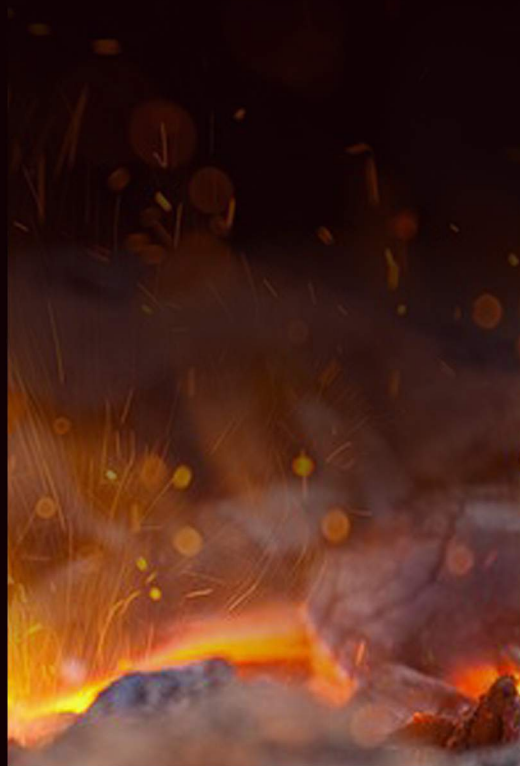

 kovkarb

mts +37529 2222566
vel +37544 5168399

e-mail 2212771@mail.ru
<https://kovkarb.by>